

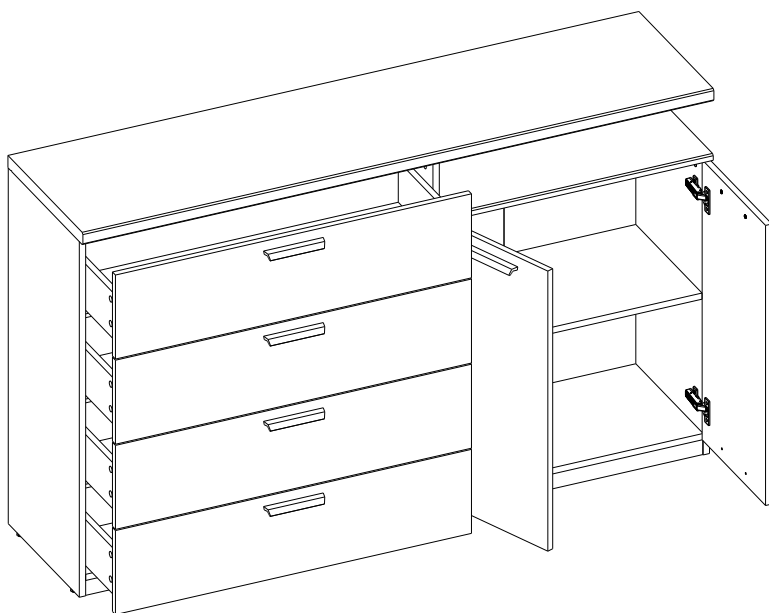

инструкция по сборке
Набор мебели для общей комнаты
«ДЕГА»

8711 д гикори кингстон серый
Тумба с полкой



габаритные размеры:

высота — 969 мм
ширина — 1588 мм
глубина — 402 мм

Дата выпуска

единая справочная служба:
8 800 100-50-22
(звонок по России бесплатный)





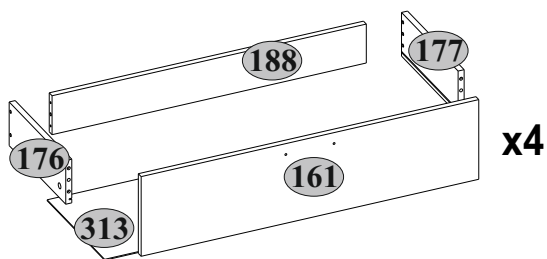
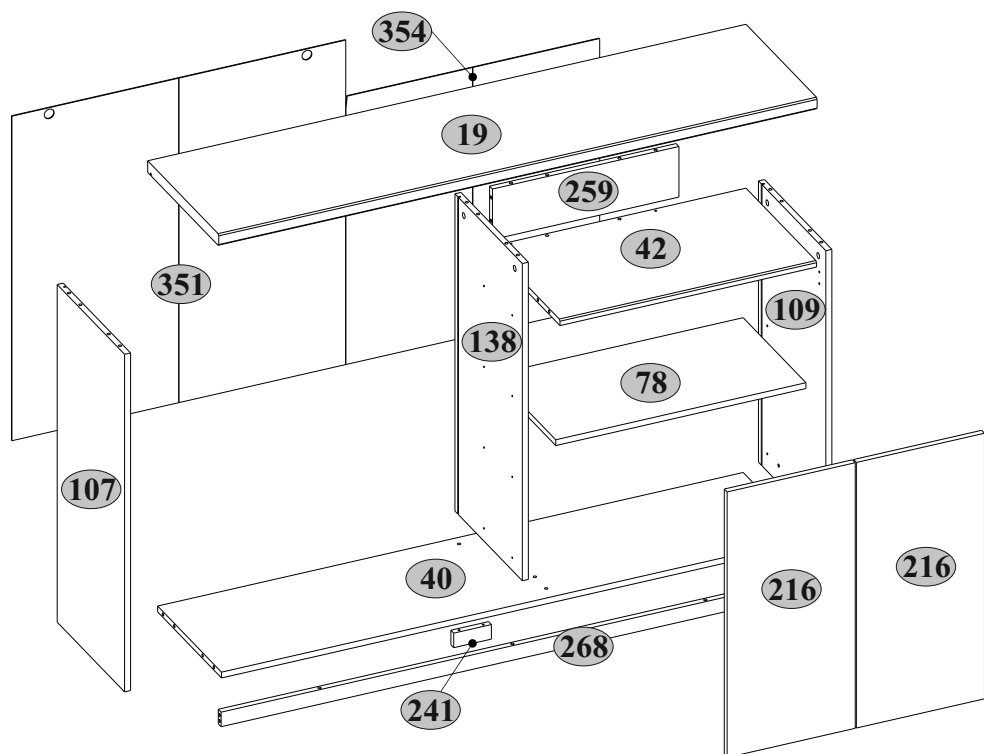



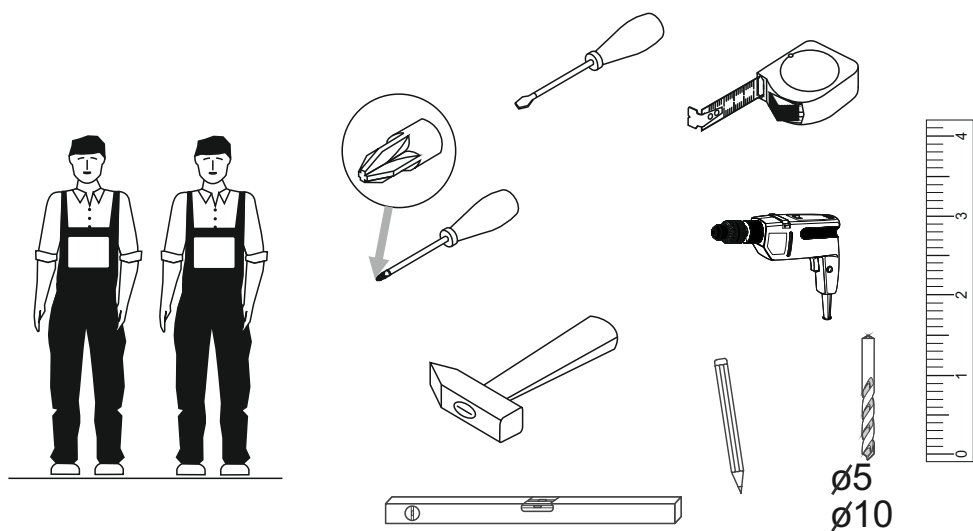



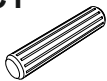

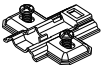

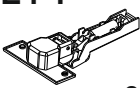



LAZURIT МЕБЕЛЬ

1

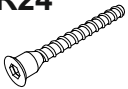



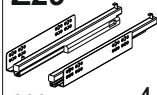

№ п/п	Наименование	Длина мм	Ширина мм	Толщина мм	Кол-во шт.	№ пачки
19	Крышка	1588	402	32	1	2/2
40	Полка соединительная	1554	361	16	1	2/2
42	Полка соединительная левая	681	399	16	1	1/2
78	Полка переставная	664	355	16	1	2/2
107	Стенка боковая левая	928	381	16	1	1/2
109	Стенка боковая правая	773	381	16	1	1/2
138	Перегородка	872	381	16	1	1/2
161	Панель передняя ящика	896	219	16	4	1/2
176	Стенка боковая ящика левая	320	120	16	4	2/2
177	Стенка боковая ящика правая	320	120	16	4	2/2
188	Стенка задняя ящика	834	107	16	4	1/2
216	Дверь	730	340	16	2	2/2
241	Опора центральная	100	40	16	1	2/2
259	Щит вертикальный левый	495	139	16	1	2/2
268	Царга	1554	40	16	1	2/2
313	Дно ящика	850	325	2,5	4	2/2
351	Стенка задняя левая	892	886	2,5	1	1/2
354	Стенка задняя правая	737	674	2,5	1	2/2





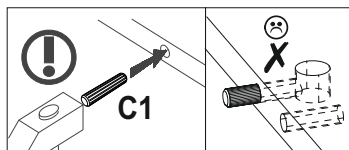
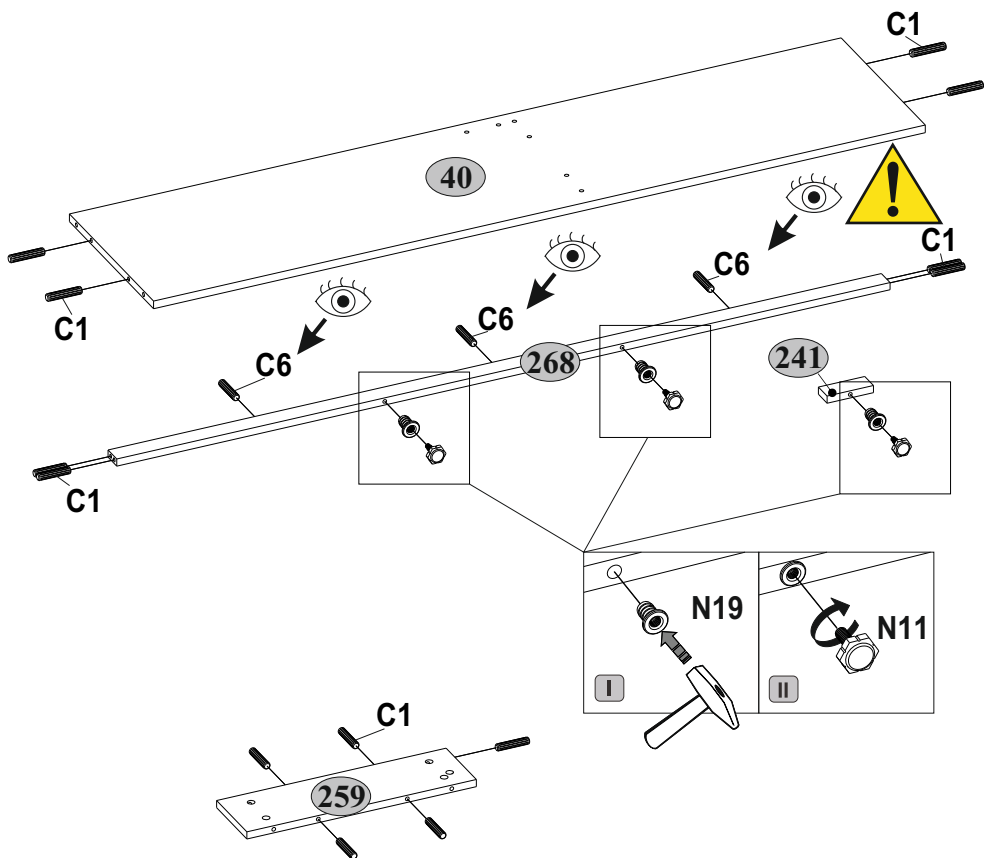

A1  7x34 33	A2  Ø15x12 33	B5  10x50 2	C1  8x35 39
C6  8x24 3	D1-1  4	H59  6	E1-1  2
E4-1  2	I  S4 1	L1  320 8	M4  M4x22 12
N11  7	N19  Ø8 7	P5  4	R3  3x20 32
R23  6,3x13 8	R24  7x50 20	R27  5,0x13 16	R102  3,5x16 28
S1  18	S5  Ø18 18	S11  Ø8 4	U  130x35x15 2
Z29  300 4			

4

C1  8x35 13	C6  8x24 3	N11  3	N19  3 Ø8 3
---	--	--	---

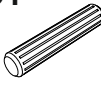



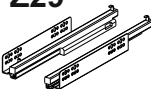

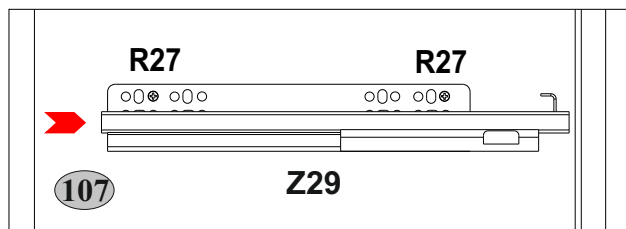
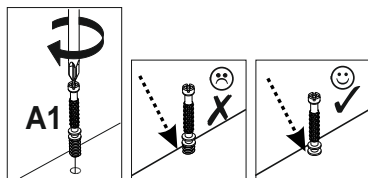
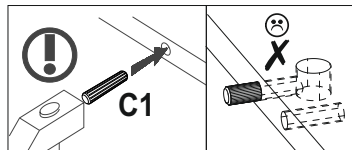
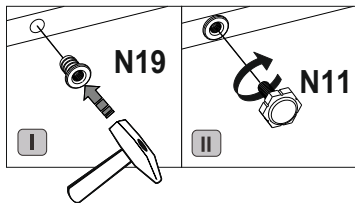
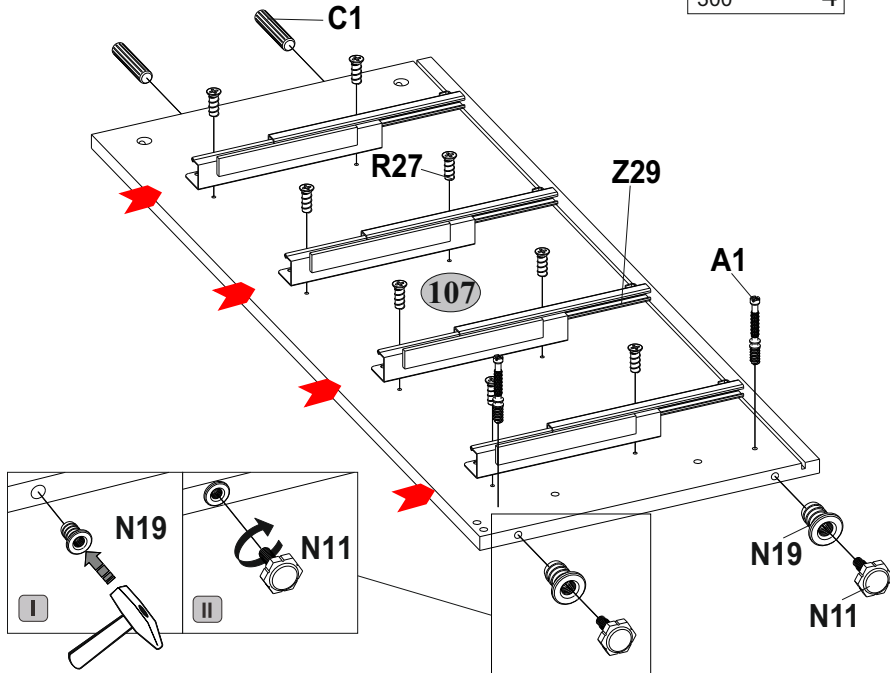
5

A1  7x34	C1  8x35	N11  2	N19  2 Ø8	R27  5,0x13	Z29  300
				8	4

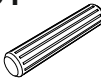
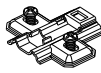



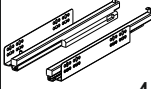

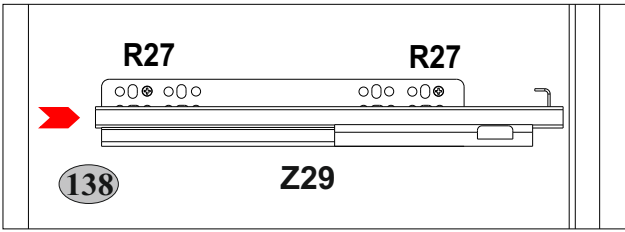
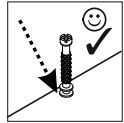
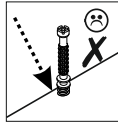
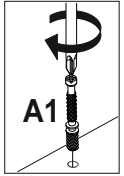
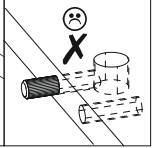
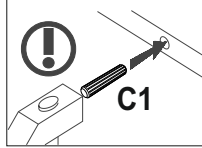
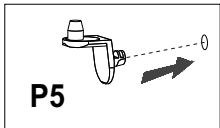
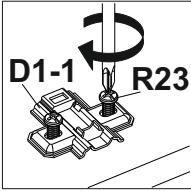
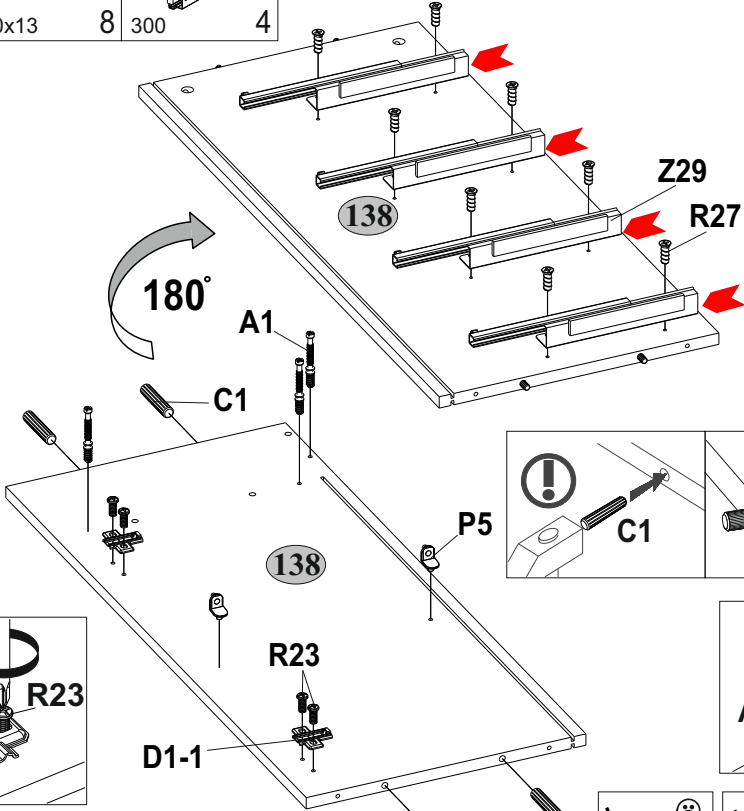

6

A1  7x34 3	C1  8x35 4	D1-1  2	P5  2	R23  6,3x13 4
R27  5,0x13 8	Z29  300 4			

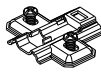

7

A1  7x34 2	C1  8x35 2	D1-1  2	N11  2	N19  Ø8 2
P5  2	R23  6,3x13 4			

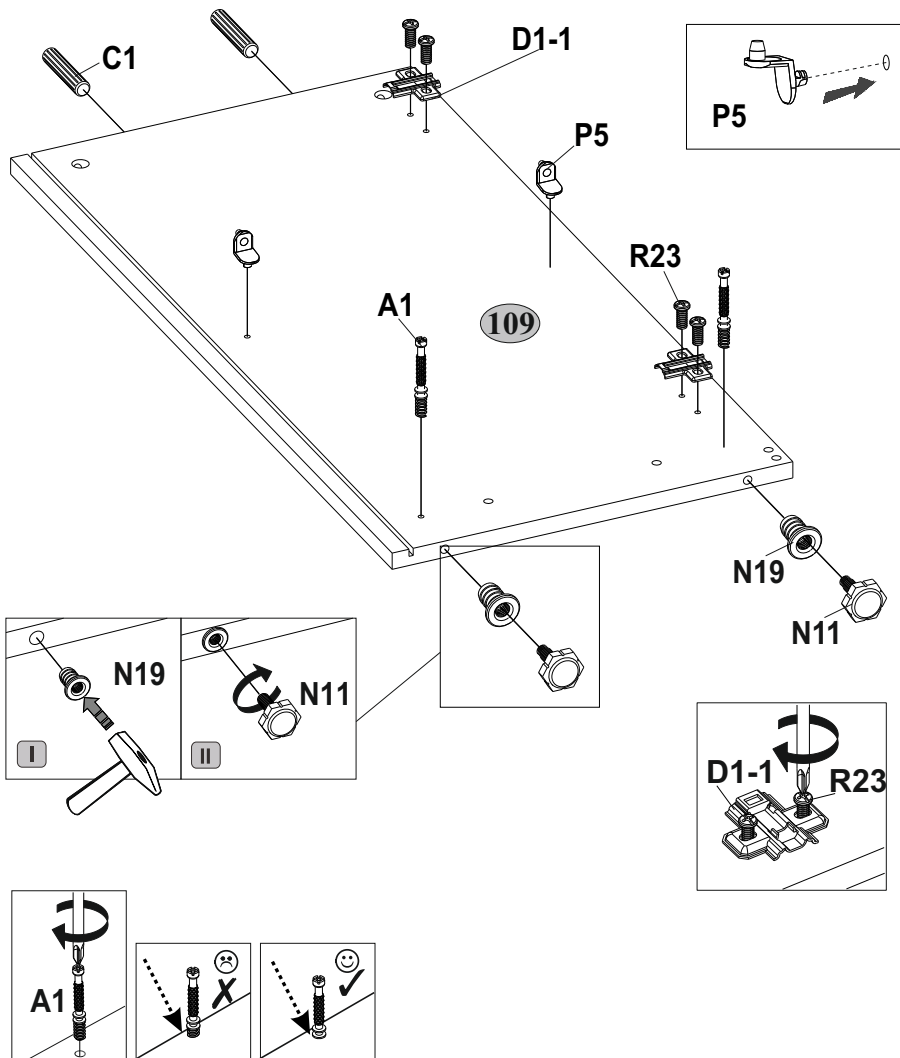

8

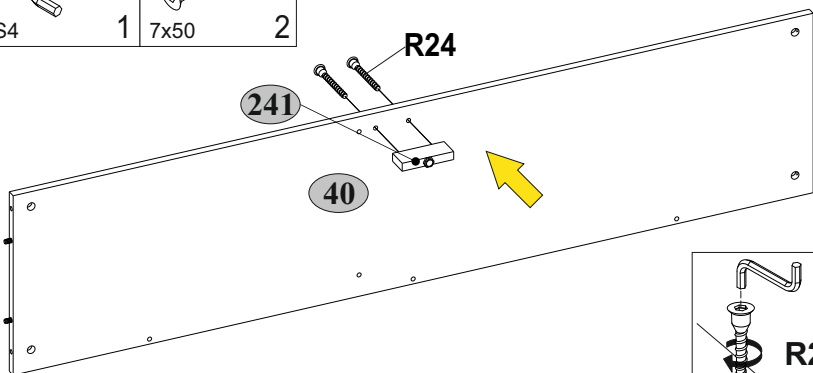
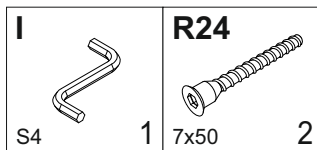

9

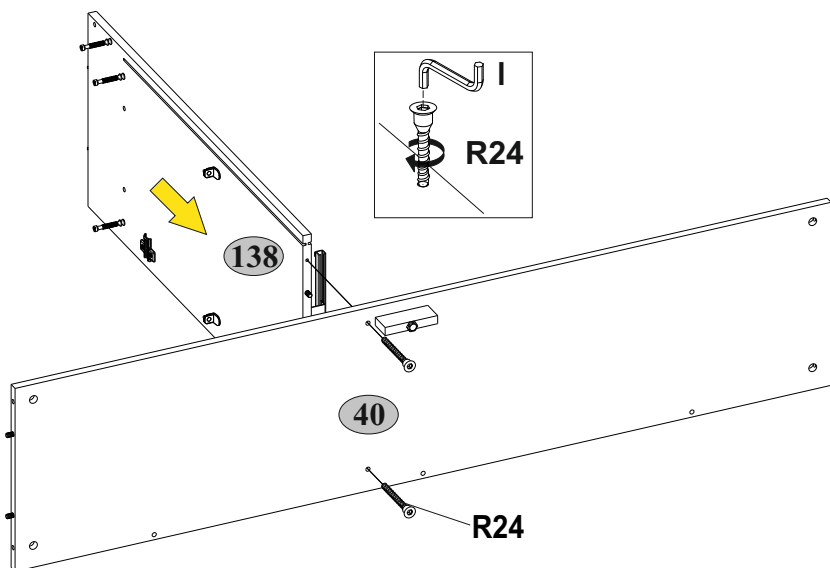
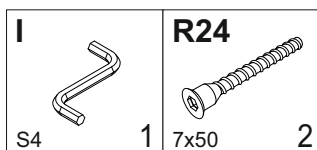

10

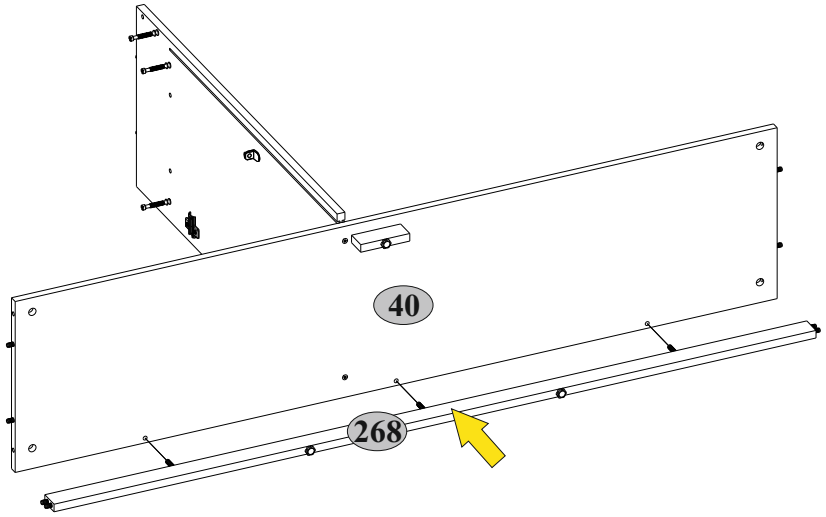

11

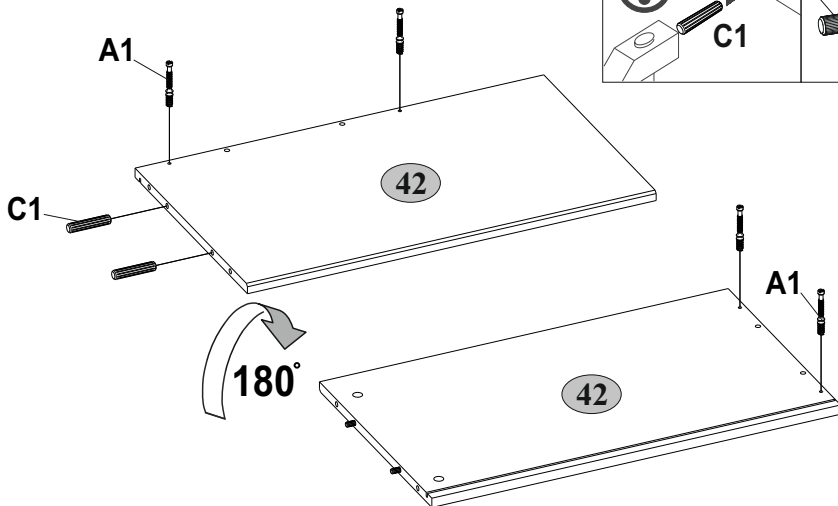
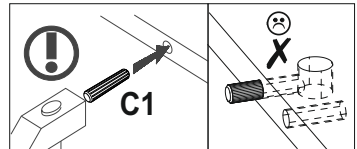
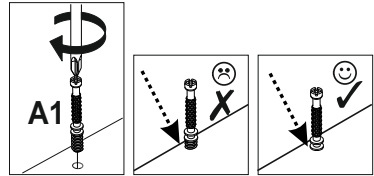
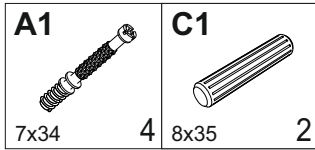

12

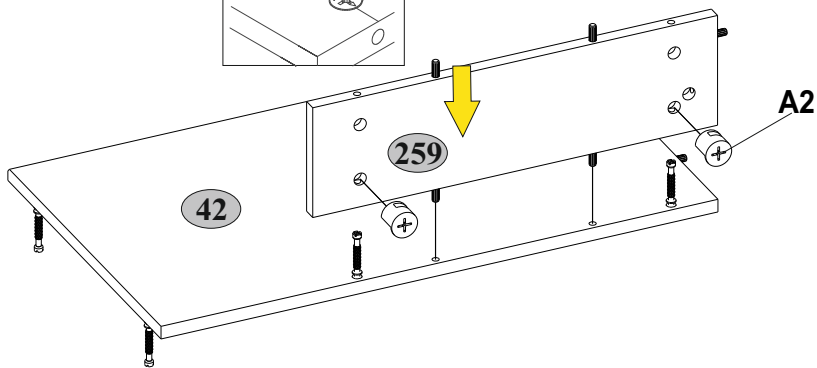
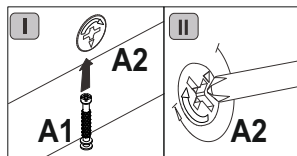
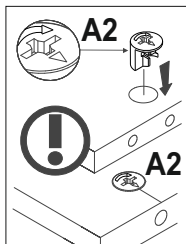
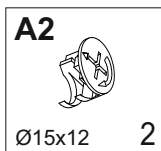

13

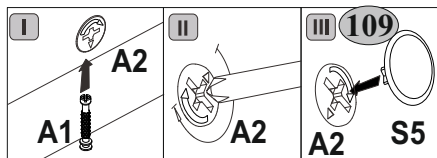
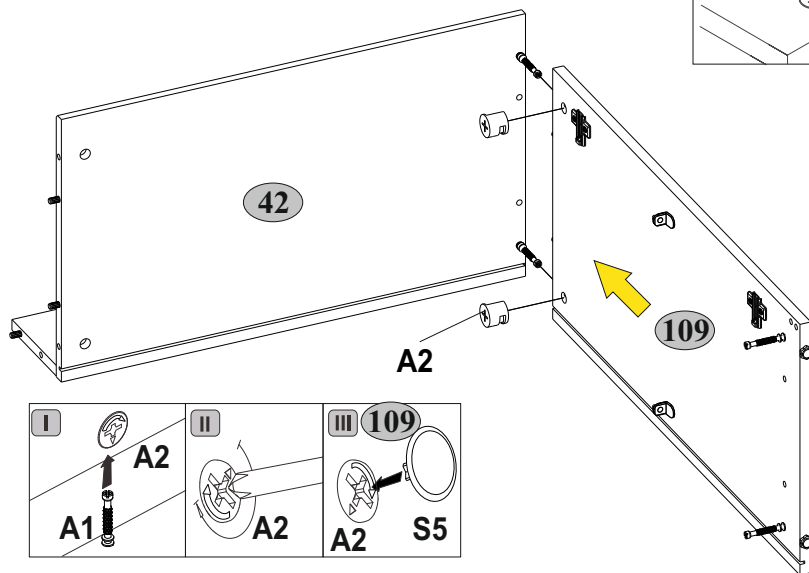
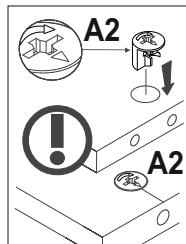
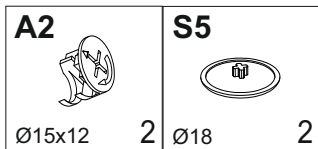

14

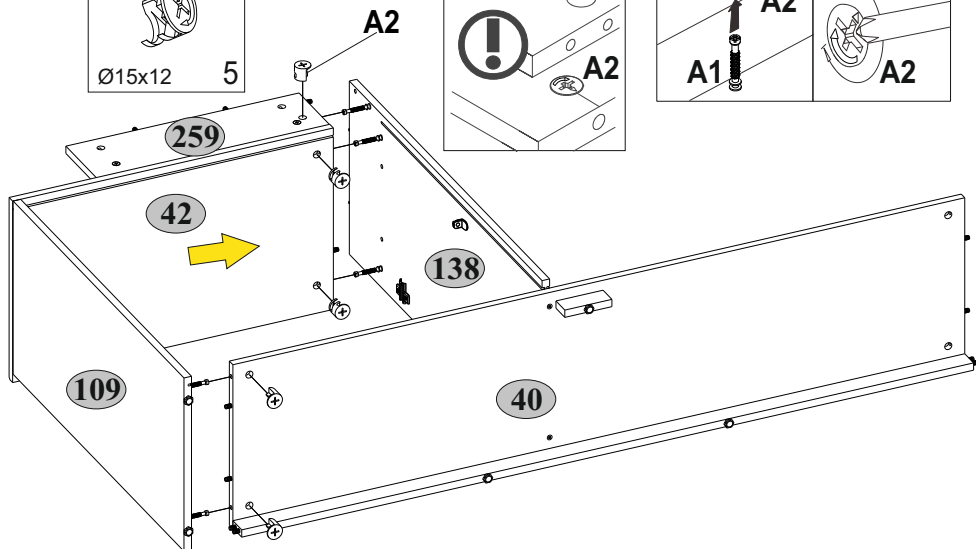
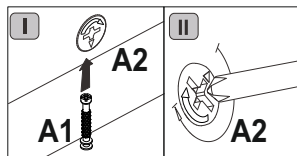
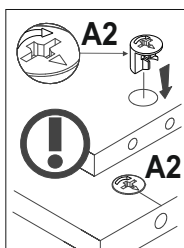
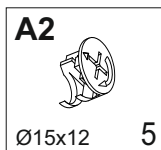

15

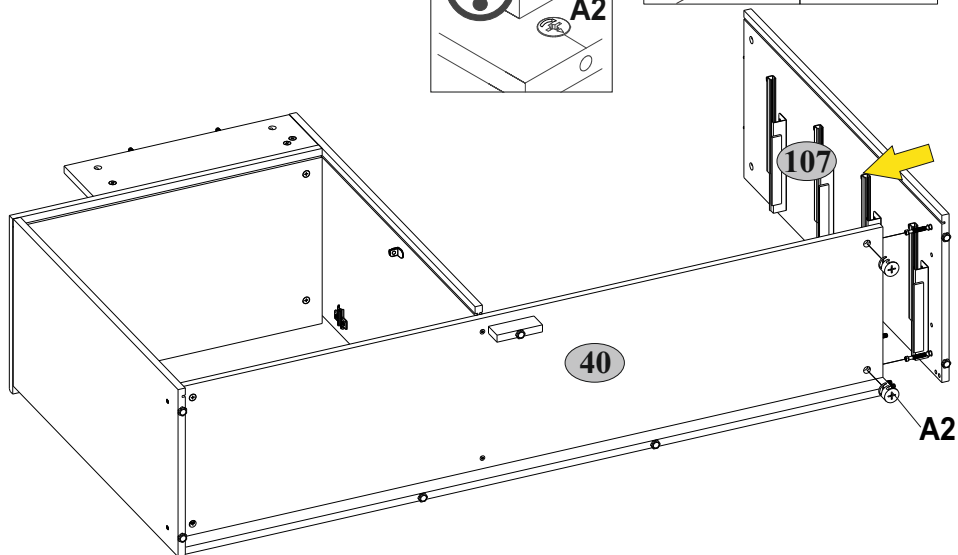
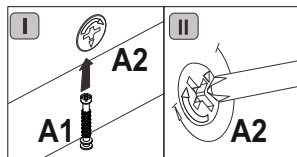
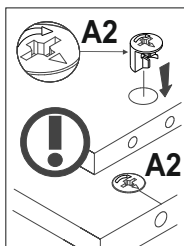
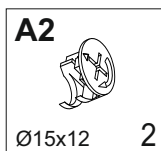

16

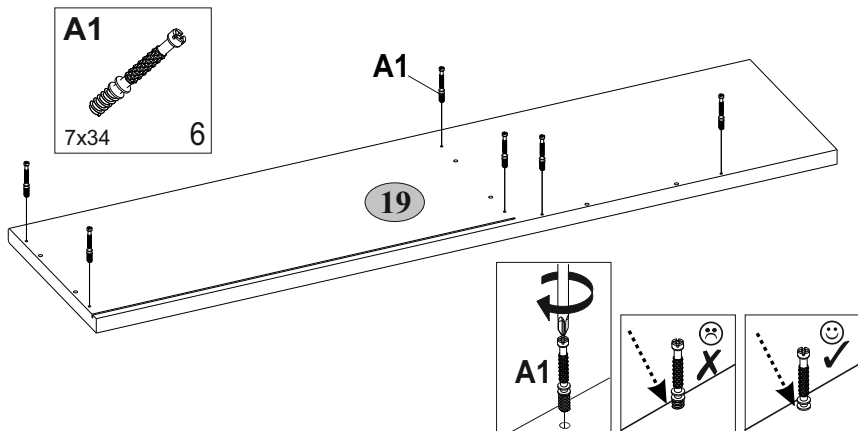

17

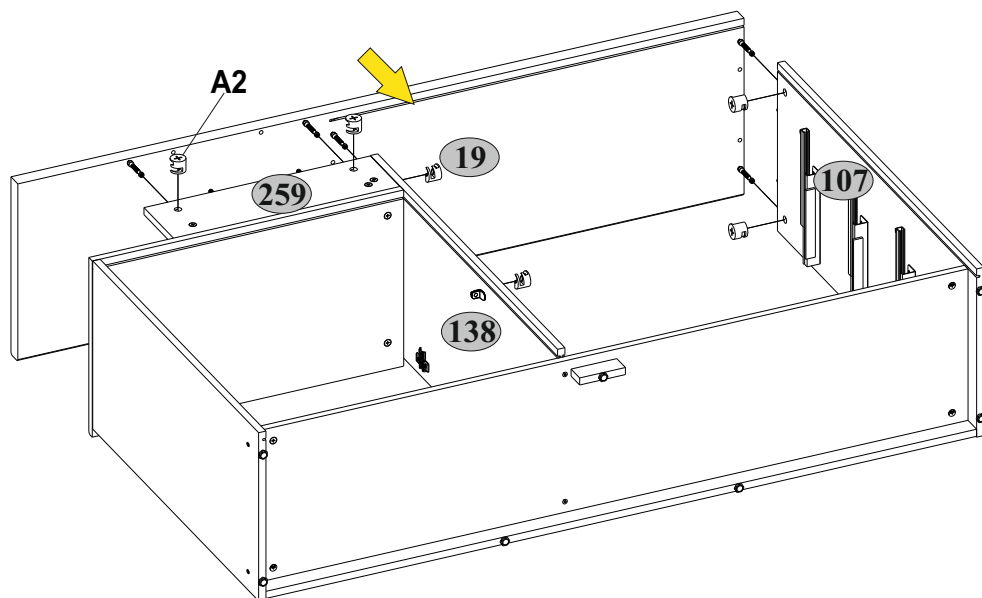
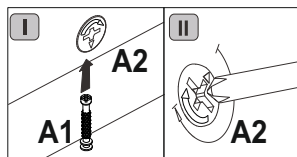
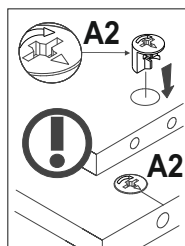
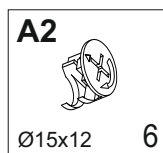

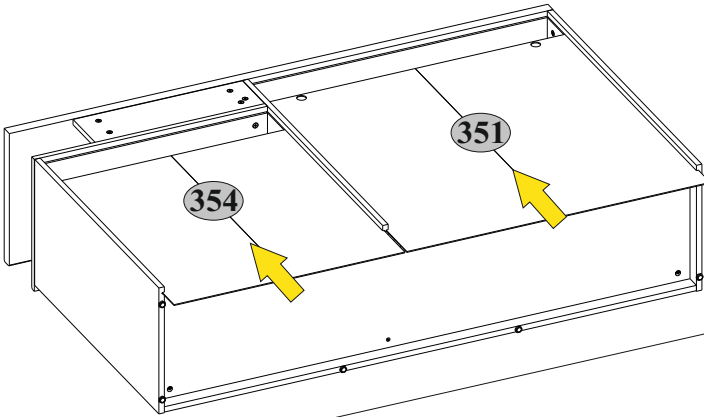

18

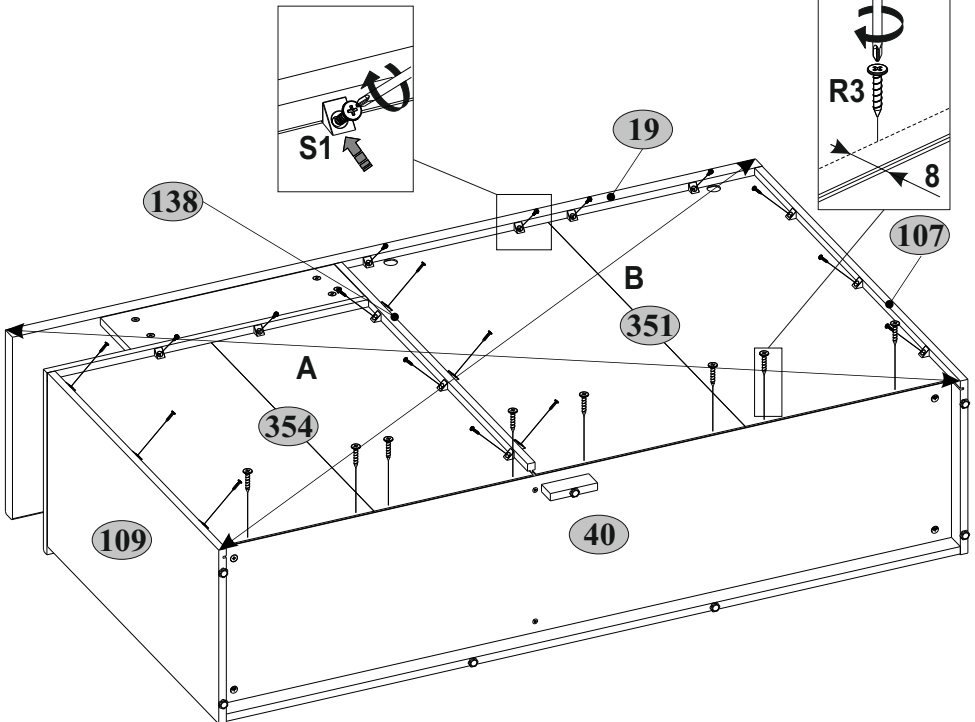
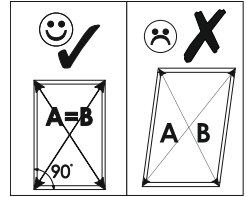
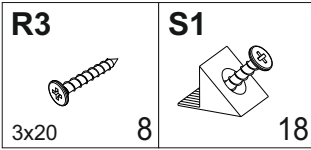

19



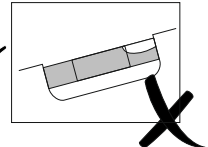
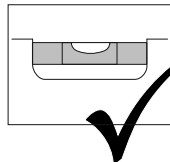
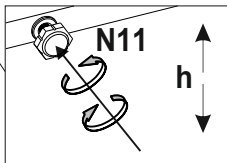
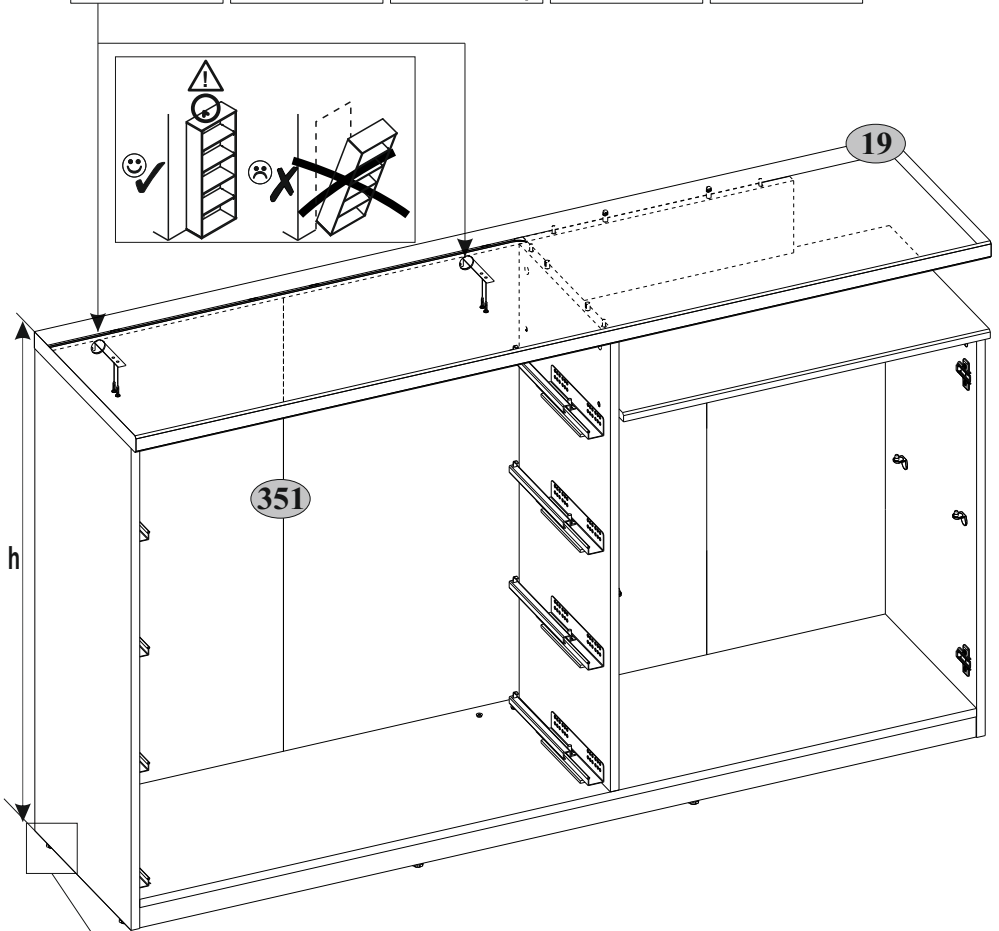
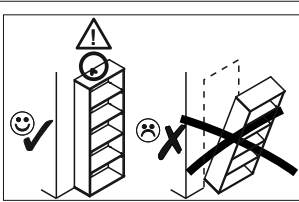
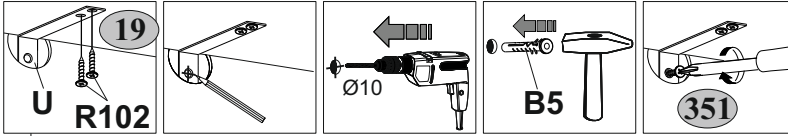

B5 	R102 	U 
10x50 2	3,5x16 4	130x35x15 2



21

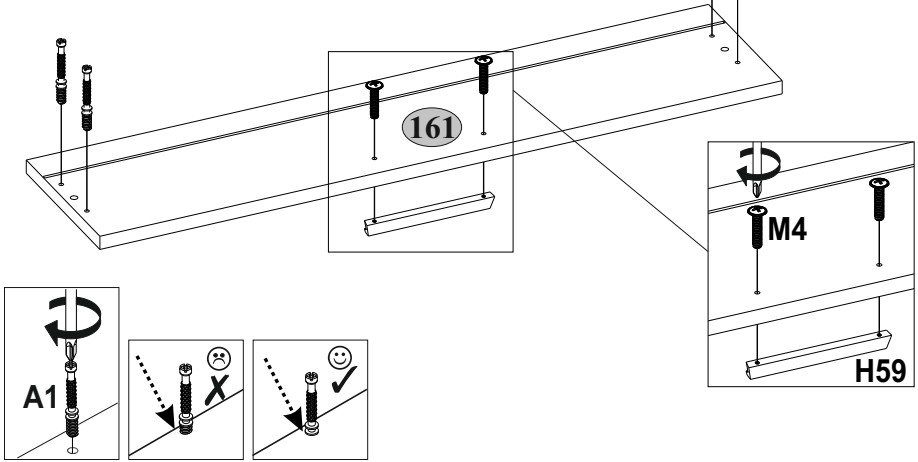

x4

A1  7x34	H59  16	M4  4 M4x22	8
--	---	---	---

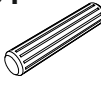

22

x4

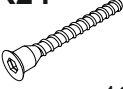
C1  8x35	I  8 S4	R24  1 7x50	16
--	---	---	----

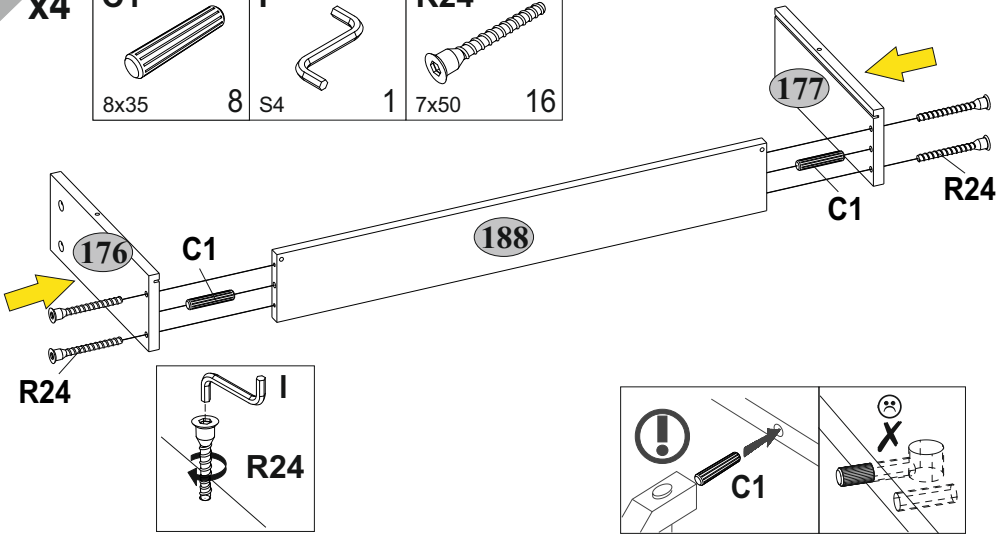

23



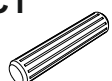

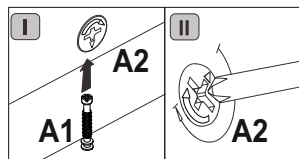
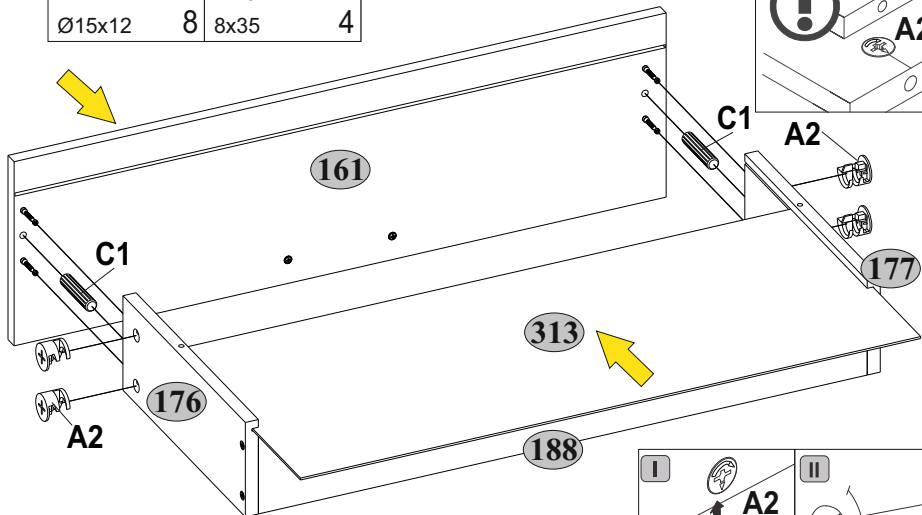
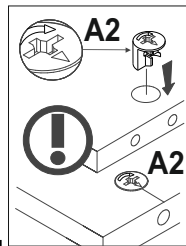
x4

A2 	C1 
Ø15x12	8 8x35 4





24

x4

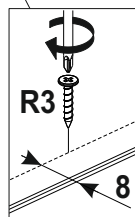
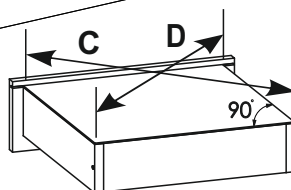
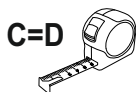
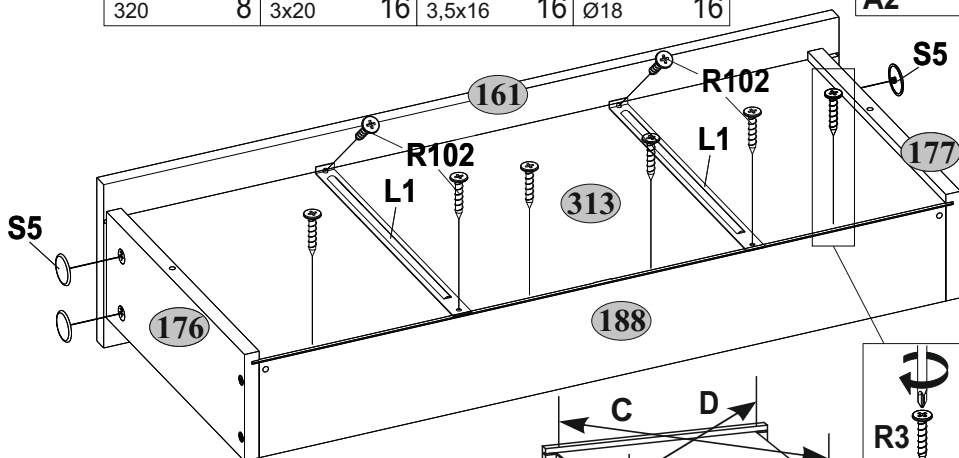
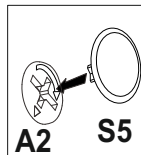
L1 	R3 	R102 	S5 
320	8 3x20	16 3,5x16	16 Ø18

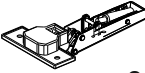
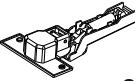

H59  2	E1-1  2	E4-1  2	M4  4 M4x22	R102  4 3,5x16	8
--	---	---	---	--	----------

S11  Ø8 4
--

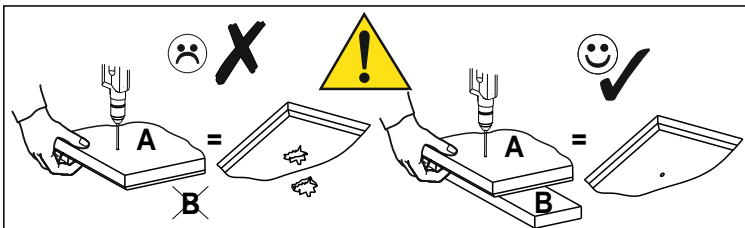
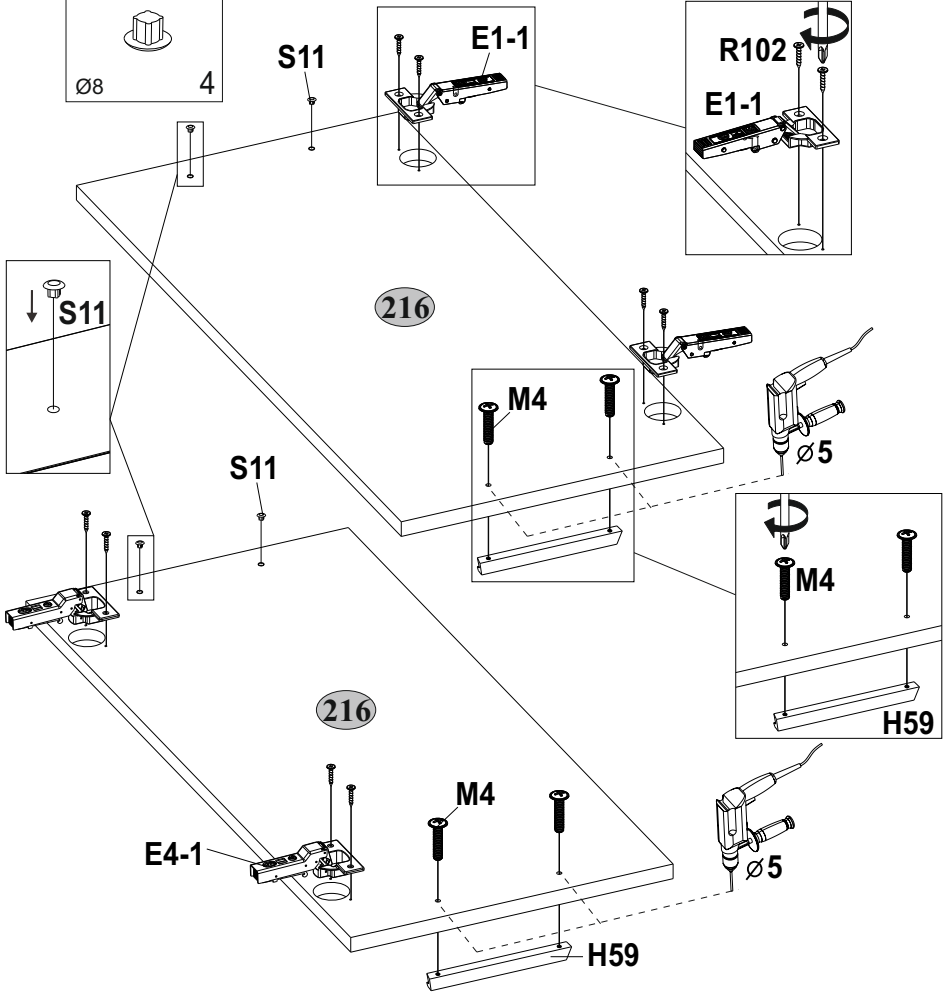

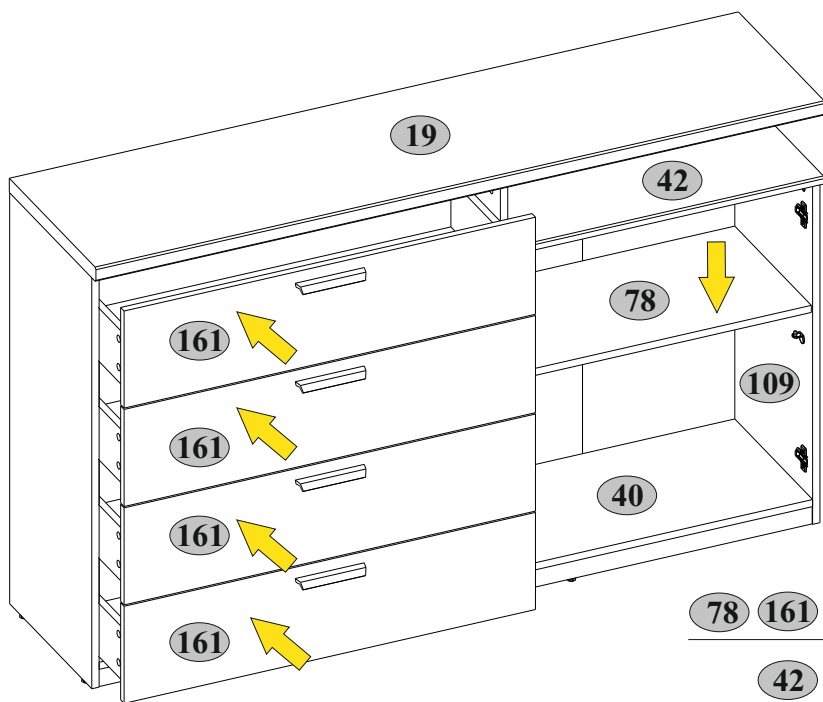
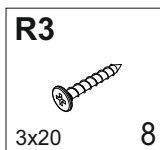

78	161	max. 5 kg
42		max. 10 kg
19	40	max. 15 kg

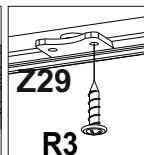
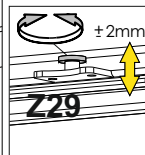
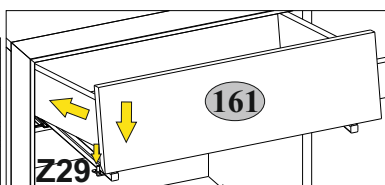
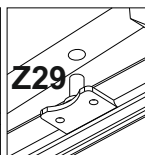
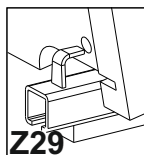

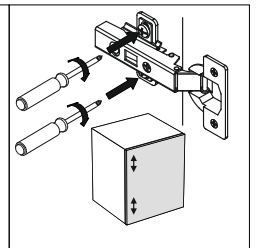
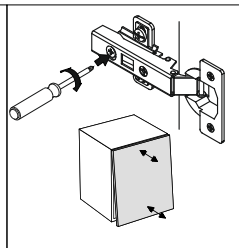
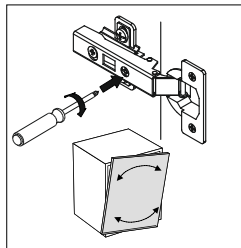
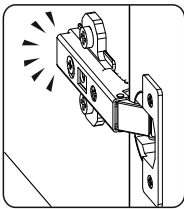
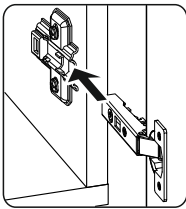
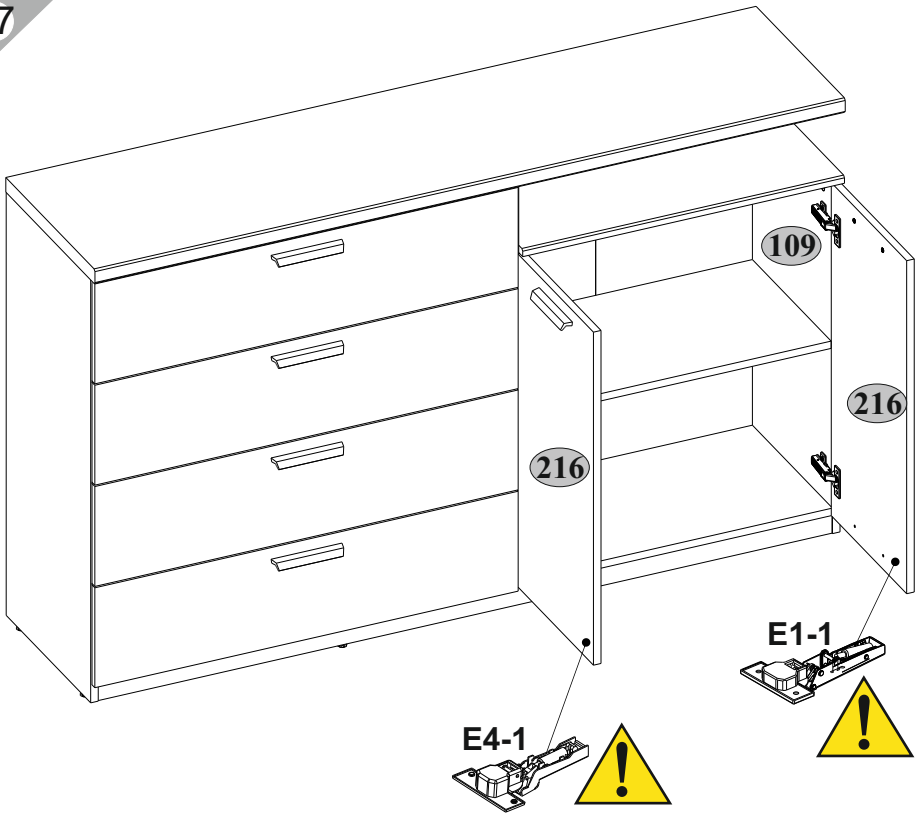



Инструкция по уходу за мебелью и правила эксплуатации

1. Мебель рекомендуется эксплуатировать в бытовых помещениях с температурой воздуха не ниже +2°C и относительной влажностью 45-70 %.
2. Мебель должна быть защищена от воздействия прямых солнечных лучей, так как это вредит внешнему виду изделий и может изменить цвет поверхности.
3. Не следует ставить на поверхность мебели горячие предметы.
4. Случайно попавшую на поверхность изделия влагу, жидкость следует снять сухой тканью.
5. Удаление пыли с полированной или лакированной поверхности следует производить сухой тканью (фланель, миткаль).
6. Полированные и лакированные поверхности мебели рекомендуется освежать специально предназначенными для этого средствами.
7. Очищать стекла рекомендуется специальными составами, нанесенными на мягкую ткань.
8. Не допускается применение соды, стиральных порошков, абразивных паст, порошков и прочих, не предназначенных для ухода за изделиями мебели препаратов.

Гарантии изготовителя

1. Гарантийный срок эксплуатации изделия - 36 месяцев со дня продажи магазином. В период гарантийного срока изготовитель гарантирует ремонт изделий или их замену, если потребителем не нарушены правила эксплуатации.
2. Претензии предъявляются потребителем непосредственно в торгующую организацию, в которой была приобретена мебель, предъявив настоящую "Инструкцию по сборке" и копию товарного чека.
3. Изделие, соответствует требованиям ГОСТ 16371-2014, ТР ТС 025/2012, ЕАЭС № В [redacted]
4. Срок службы мебели - 5 лет.
5. Предприятие-изготовитель оставляет за собой право вносить изменения в конструкцию изделия, не ухудшая его конструктивные и эксплуатационные характеристики.
6. Для сборки изделий рекомендуется привлекать квалифицированных специалистов.

Запах.

От новой мебели может исходить запах материалов, из которых она изготовлена. Запах может сохраняться в течение трёх недель с момента сборки. Для снижения интенсивности запаха рекомендуется:

-для мягкой мебели - пропылесосить изделие и проветрить помещение.

Повторять 3-4 раза в день.

-для корпусной мебели – протирать ткань, смоченной мягким моющим средством, вытирать чистой сухой тканью и проветривать помещение, предварительно открывая все двери и ящики изделия.

Повторять 3-4 раза в день.

Важно! Сохраните, пожалуйста, инструкцию в случае повторной сборки мебели или рекламации. В случае составления рекламации пользуйтесь, пожалуйста, обозначением из инструкции сборки.