

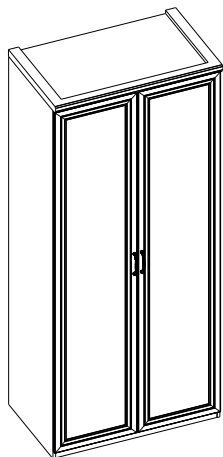

инструкция по сборке
Набор мебели для общей комнаты
«ЛУАРА»

км0009 д серый
Шкаф двухстворчатый



габаритные размеры:

высота — 2304 мм
ширина — 990 мм
глубина — 618 мм

км0009 дз серый зеркало
Шкаф двухстворчатый

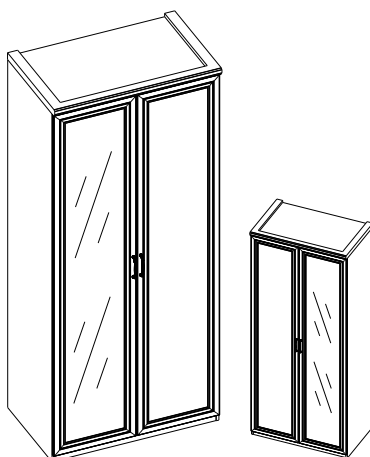

габаритные размеры:

высота — 2304 мм
ширина — 990 мм
глубина — 618 мм

км0009 з серый зеркало
Шкаф двухстворчатый

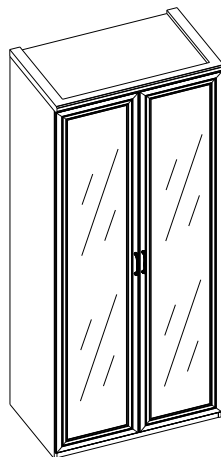

габаритные размеры:

высота — 2304 мм
ширина — 990 мм
глубина — 618 мм

Элемент для докупки:
км0002 д серый Комплект
ящиков к арт. км0009

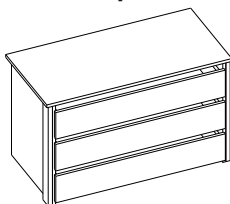

габаритные размеры:

высота — 576 мм
ширина — 956 мм
глубина — 484 мм

Дата выпуска

единая справочная служба:
8 800 100-50-22
(звонок по России бесплатный)

1

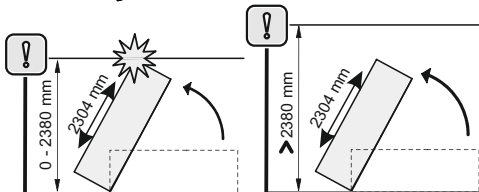
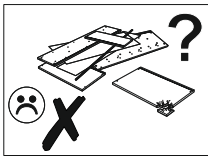
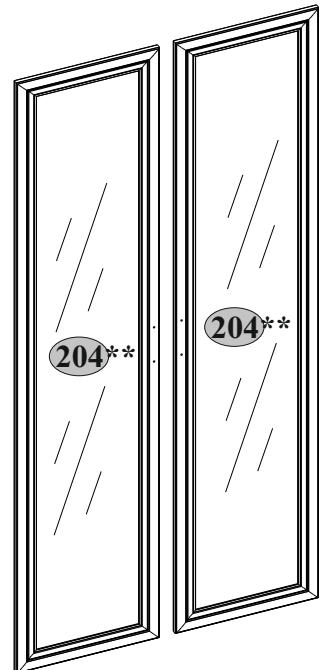
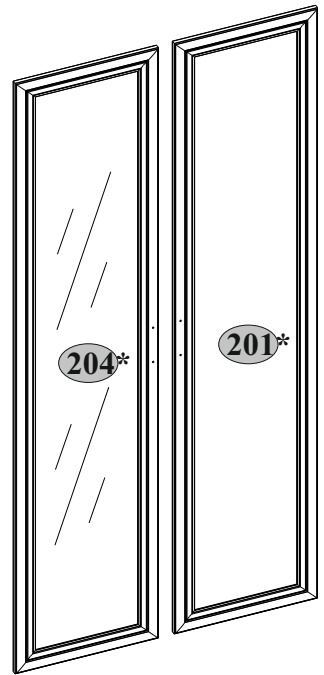
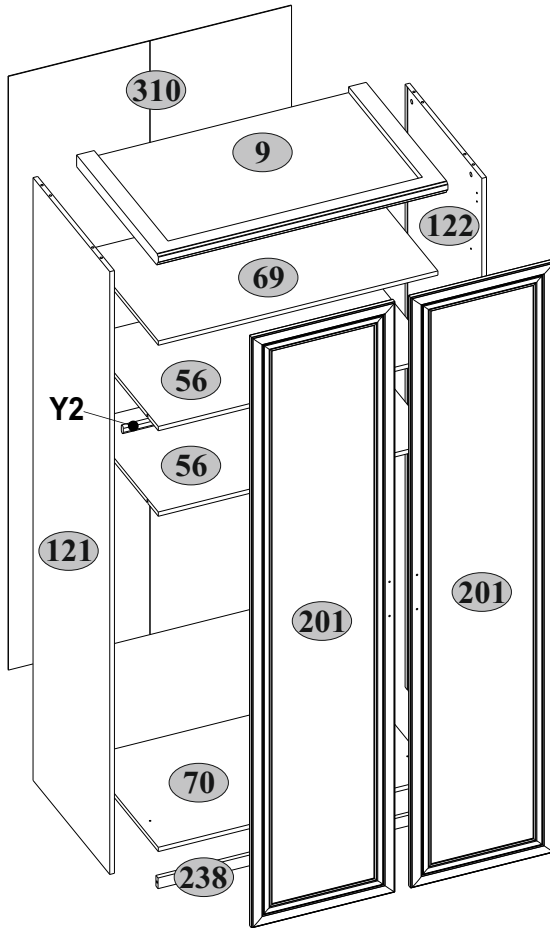

*-км0009 дз серый зеркало Шкаф двухстворчатый

** -км0009 з серый зеркало Шкаф двухстворчатый

2

км0009 д серый Шкаф двухстворчатый

№ п/п	Наименование	Длина	Ширина	Толщина	Кол-во шт.	№ пачки
		мм	мм	мм		
9	Щит верхний	990	618	44	1	1/3
56	Полка соединительная	956	560	16	2	1/3
69	Полка соединительная верхняя	956	560	16	1	1/3
70	Полка соединительная нижняя	956	560	16	1	1/3
121	Стенка боковая левая	2256	580	16	1	2/3
122	Стенка боковая правая	2256	580	16	1	2/3
201	Дверь	2210	490	19	2 (1*)	3/3
204	Дверь	2210	490	19	1* (2**)	3/3
238	Царга	956	40	16	1	1/3
310	Стенка задняя	2222	968	2,5	1	2/3
У2	Труба овальная	949			1	1/3
230	Царга левая	379	80	16	1	2/3
	Комплект фурнитуры				1	1/3

*-км0009 дз серый зеркало Шкаф двухстворчатый

** -км0009 з серый зеркало Шкаф двухстворчатый

3

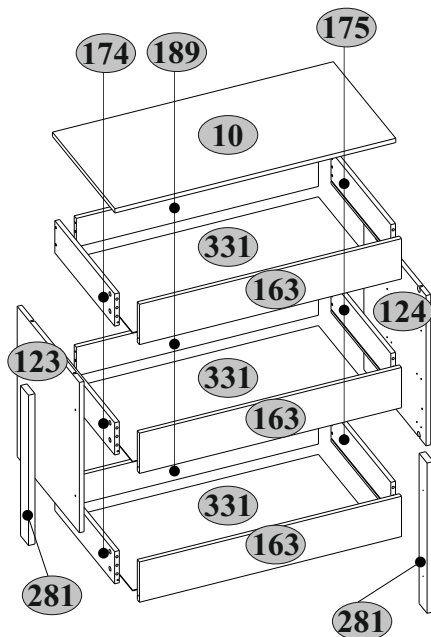

Элемент для докупки:
км0002 д серый Комплект
ящиков к арт. км0009















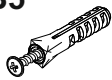
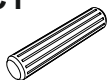
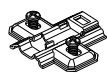
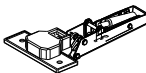

4

Элемент для докупки:
км0002 д серый Комплект ящиков к арт. км0009

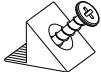
№ п/п	Наименование	Длина мм	Ширина мм	Толщина мм	Кол-во шт.	№ пачки
10	Щит верхний	956	470	16	1	1/1
123	Перегородка левая	560	468	16	1	1/1
124	Перегородка правая	560	468	16	1	1/1
163	Панель передняя ящика	876	150	16	3	1/1
174	Стенка боковая ящика левая	450	120	16	3	1/1
175	Стенка боковая ящика правая	450	120	16	3	1/1
189	Стенка задняя ящика	824	107	16	3	1/1
281	Планка вертикальная	560	60	22	2	1/1
331	Дно ящика	838	455	2,5	3	1/1
	Комплект фурнитуры				1	1/1











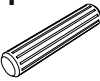

5

км0009 д серый Шкаф двухстворчатый
(км0009 дз серый зеркало Шкаф двухстворчатый
км0009 з серый зеркало Шкаф двухстворчатый)

A1  7x34 12	A2  Ø15x12 12	A7  8 20x13 8	A8  8
B5  10x50 1	C1  8x35 14	D1-1  8	E1-1  8
H55  2	M4  M4x22 4	N1  4 3x20 8	R3  8
R23  6,3x13 16	R102  3,5x16 26	S1  20	S5  Ø18 8
S8  Ø14 4	U  130x35x15 1	U10  2	Y1  2

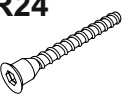

6

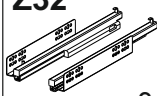
Элемент для докупки:
км0002 д серый Комплект ящиков к арт. км0009

A1  7x34 12	A2  Ø15x12 12	A7  8	A8  20x13 8
C1  8x35 12	I  S4 1	L5  450 3	R3  3x20 18
R24  7x50 12	R27  5,0x13 24	R33  4x30 4	R102  3,5x16 6
S5  Ø18 12	Z32  450 3		

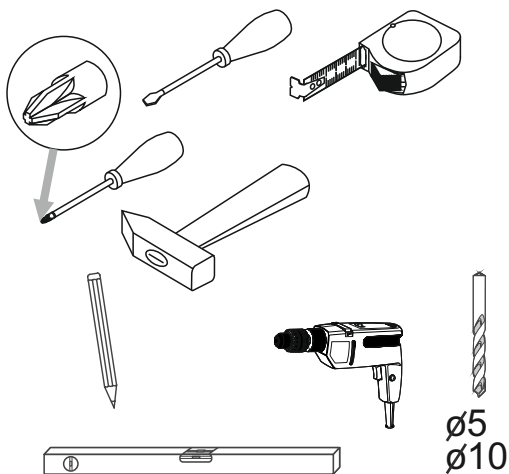
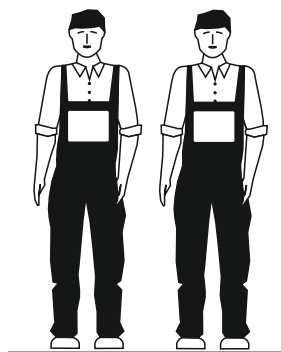
7

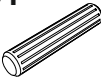
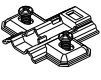

A1  7x34 8	C1  8x35 4	D1-1  8	N1  4	R23  6,3x13 16
---	---	---	---	---

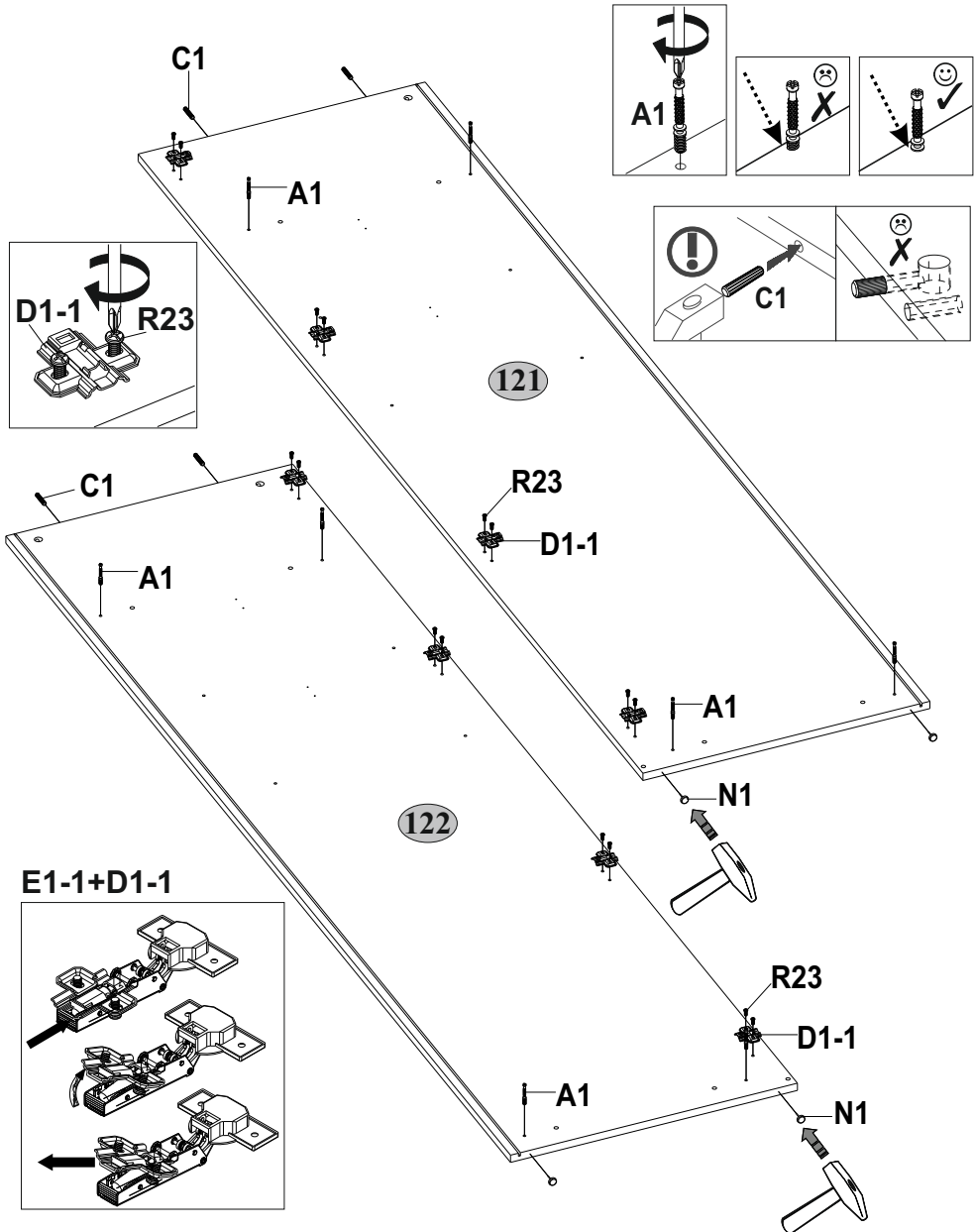

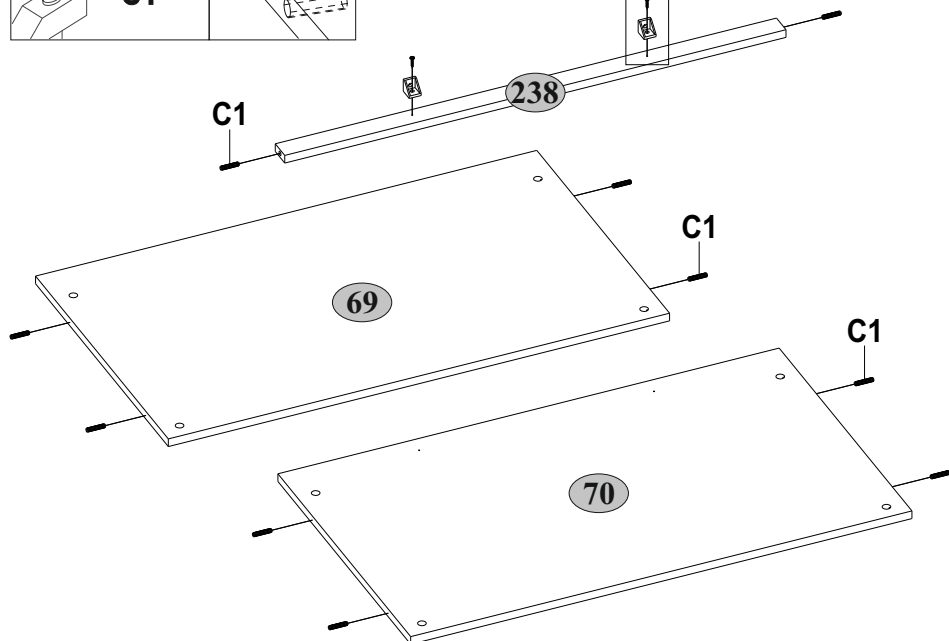
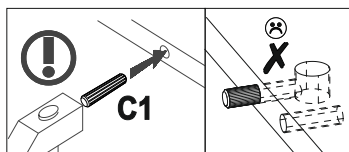
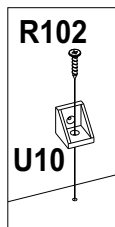
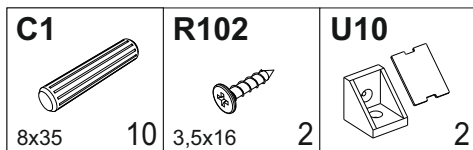

9

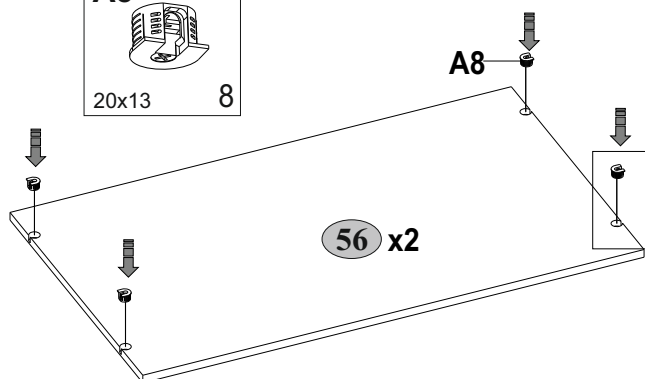
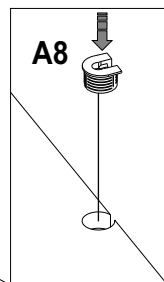
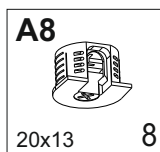

10



<p>A2</p>  <p>Ø15x12 8</p>	<p>R102</p>  <p>3,5x16 2</p>	<p>S5</p>  <p>Ø18 4</p>
---	---	--

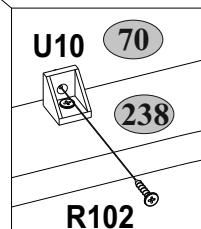
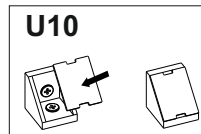
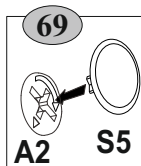
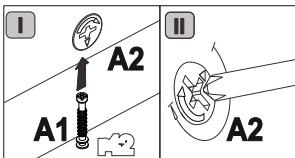
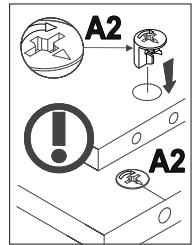
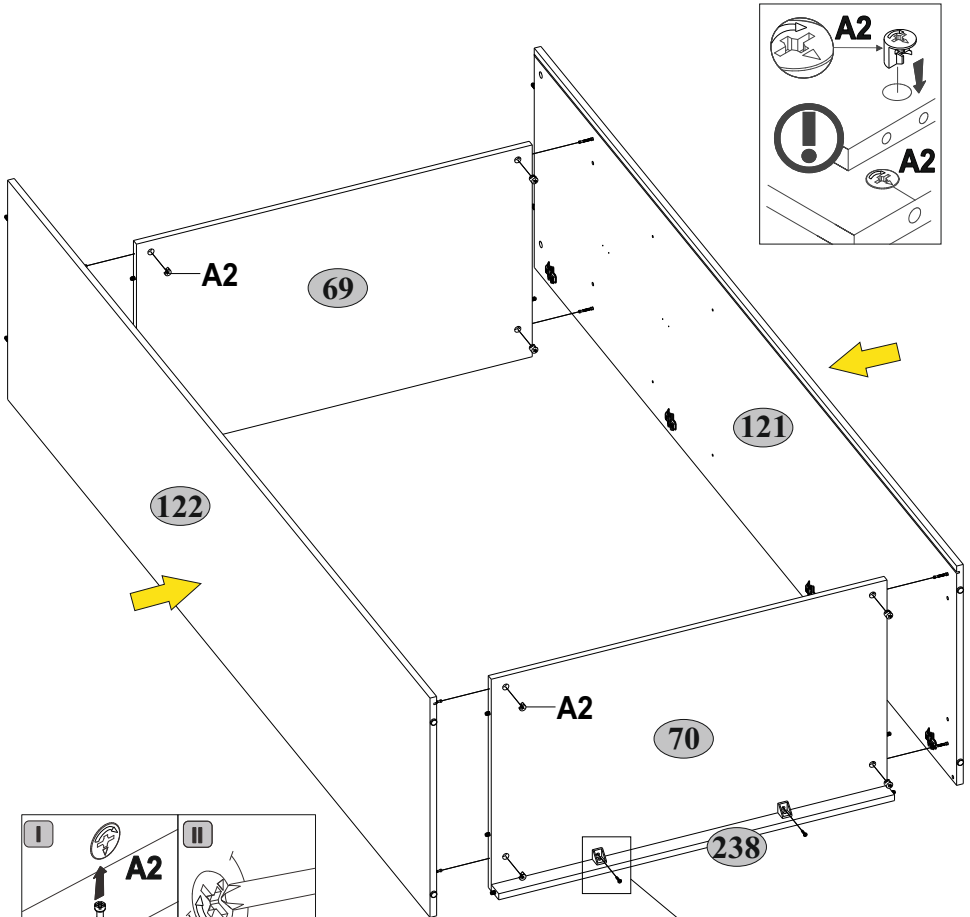



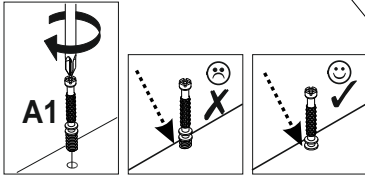
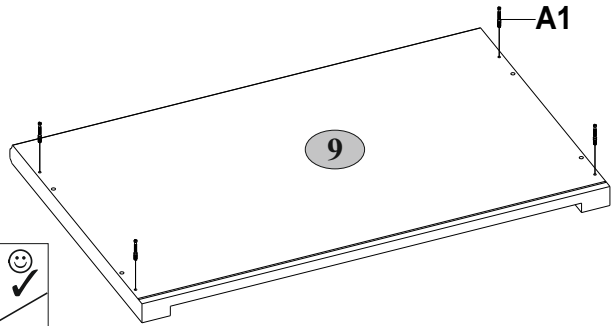
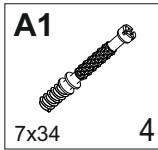

12

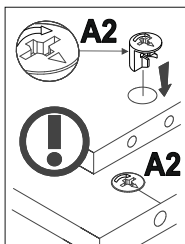
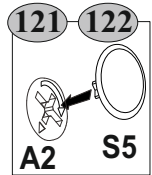
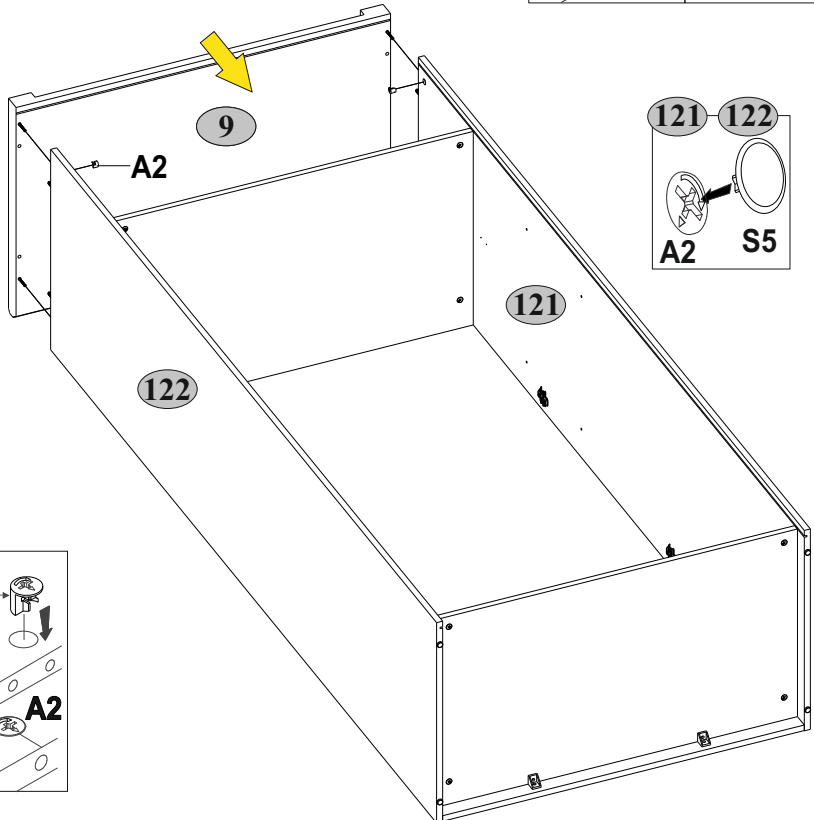
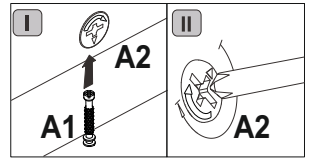
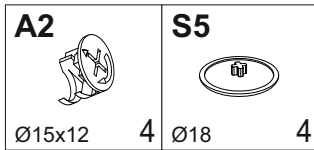

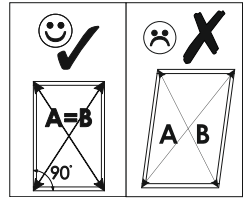
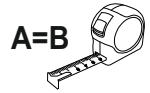
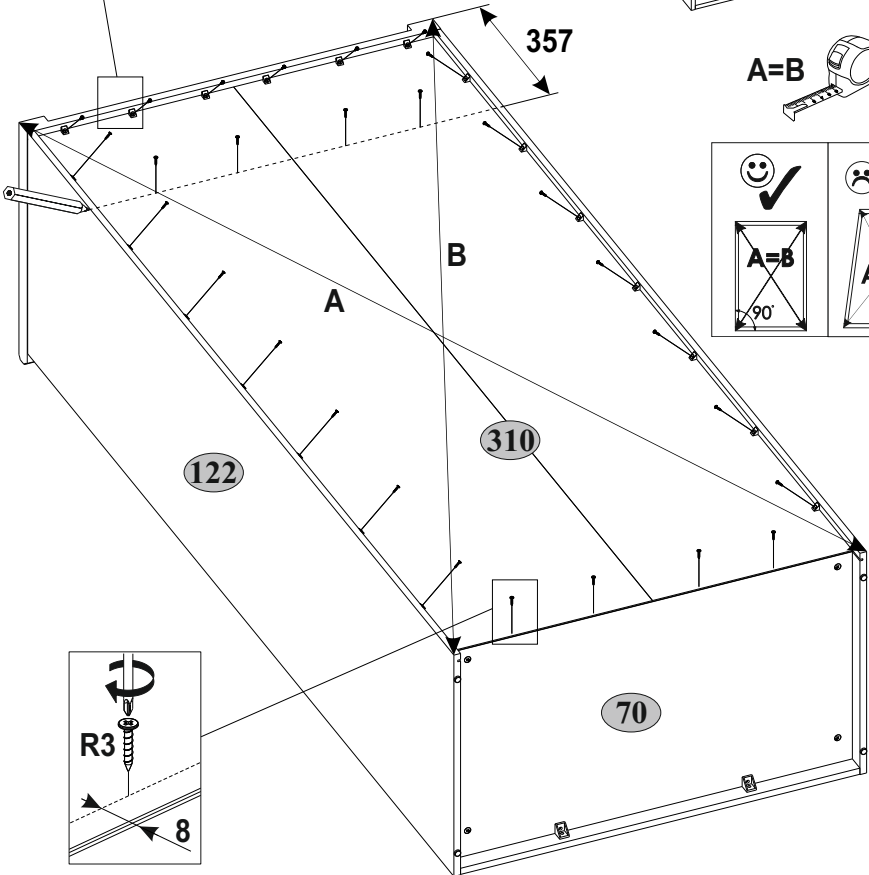
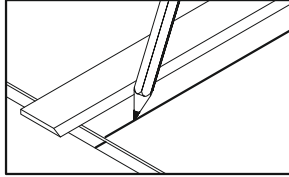
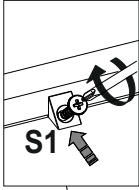
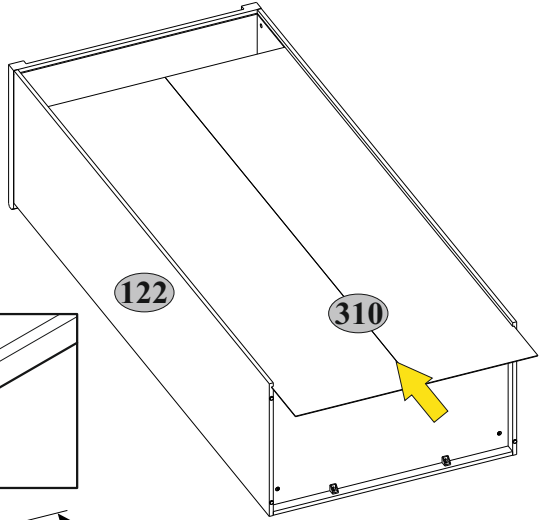
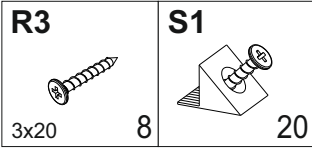

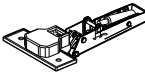

13



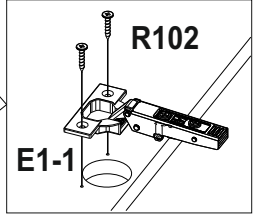
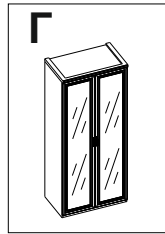
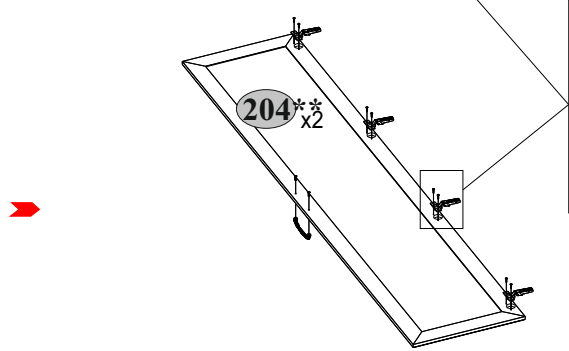
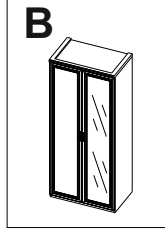
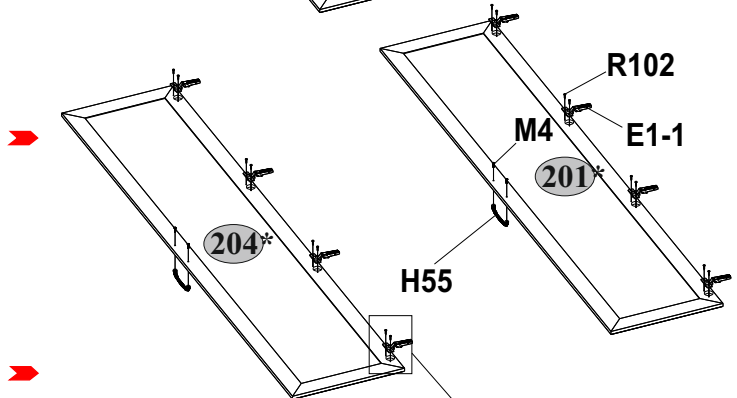
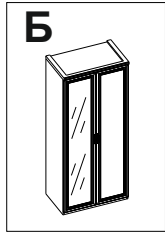
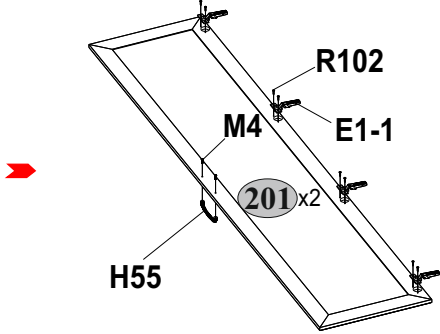
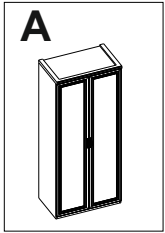





E1-1  8	H55  2	M4  M4x22 4	R102  3,5x16 16
---	--	---	---

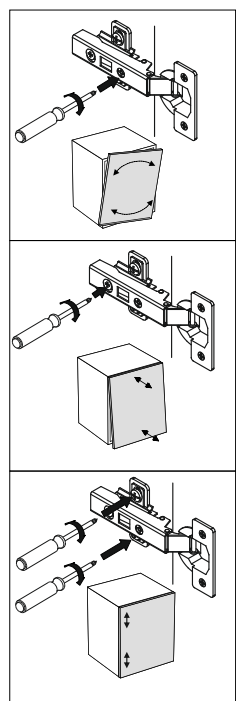
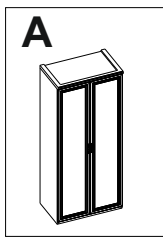
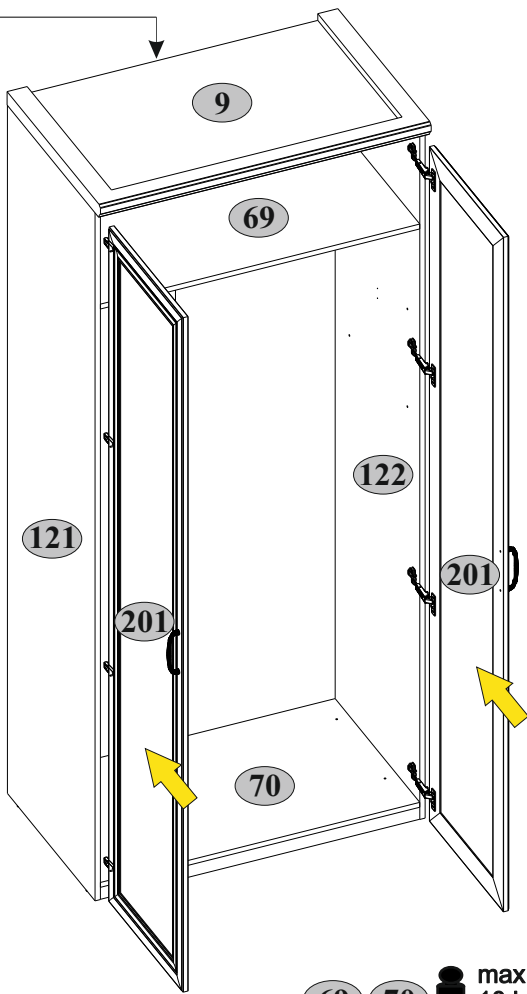
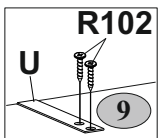
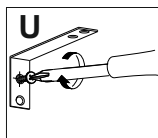
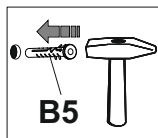
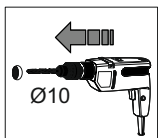
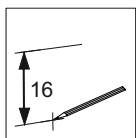
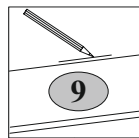

<p>B5</p>  <p>10x50 1</p>	<p>R102</p>  <p>3,5x16 2</p>	<p>U</p>  <p>130x35x15 1</p>
--	---	---





69 70  max. 10 kg

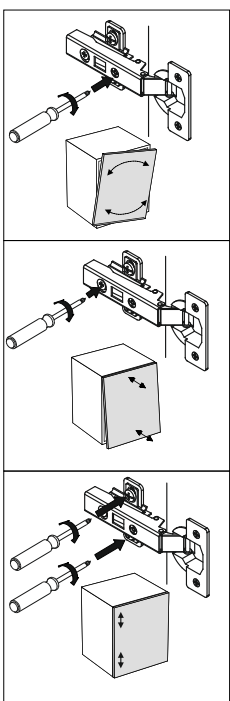
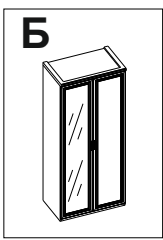
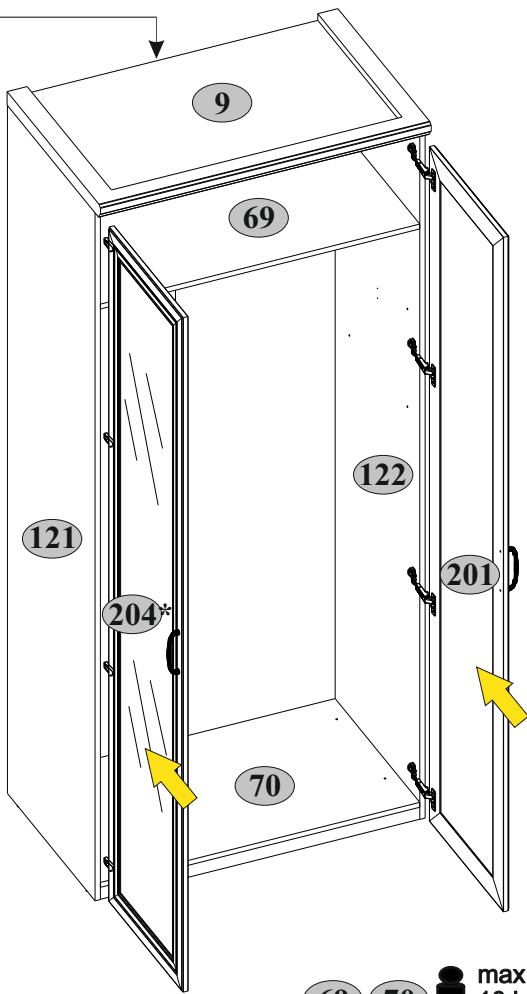
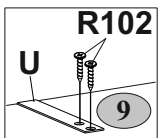
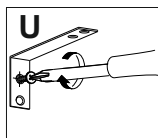
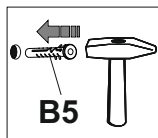
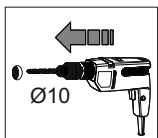
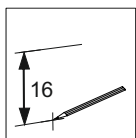
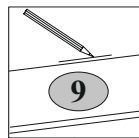

<p>B5</p>  <p>10x50 1</p>	<p>R102</p>  <p>3,5x16 2</p>	<p>U</p>  <p>130x35x15 1</p>
--	---	---

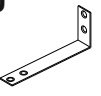

69 70  max. 10 kg

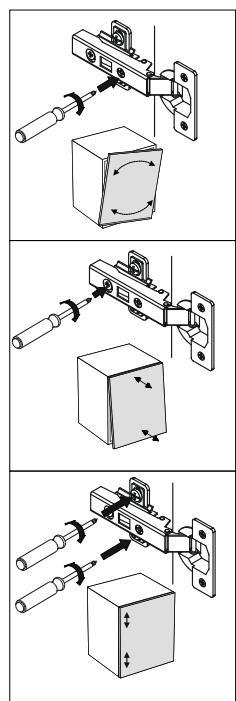
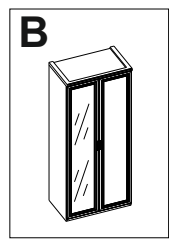
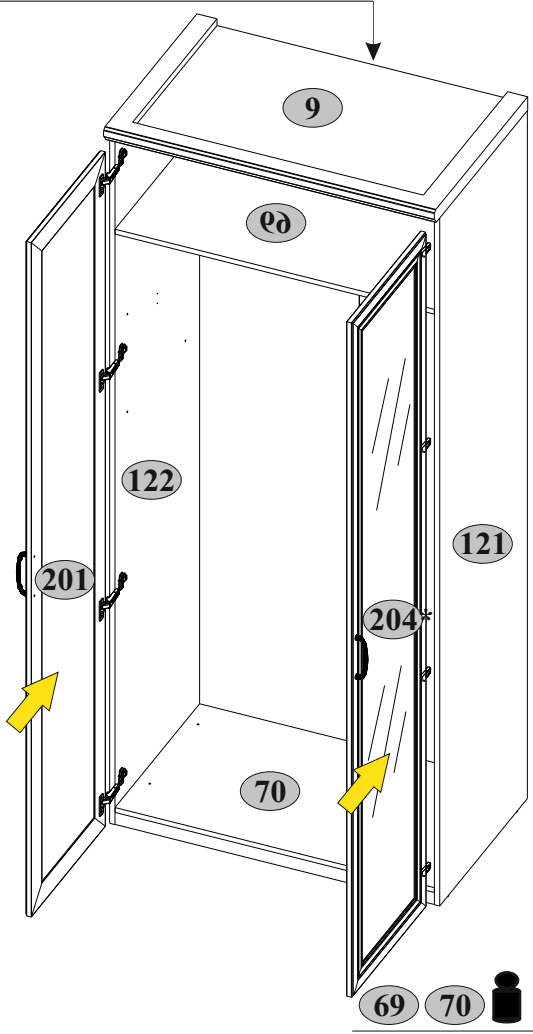
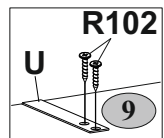
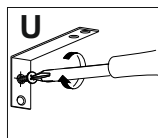
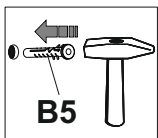
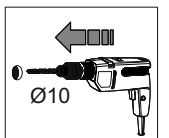
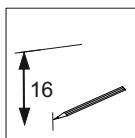
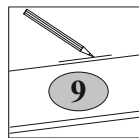

<p>B5</p>  <p>10x50 1</p>	<p>R102</p>  <p>3,5x16 2</p>	<p>U</p>  <p>130x35x15 1</p>
---	--	--

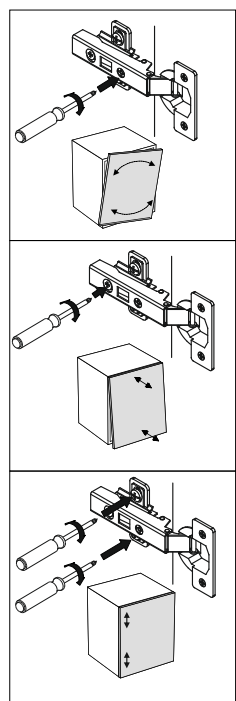
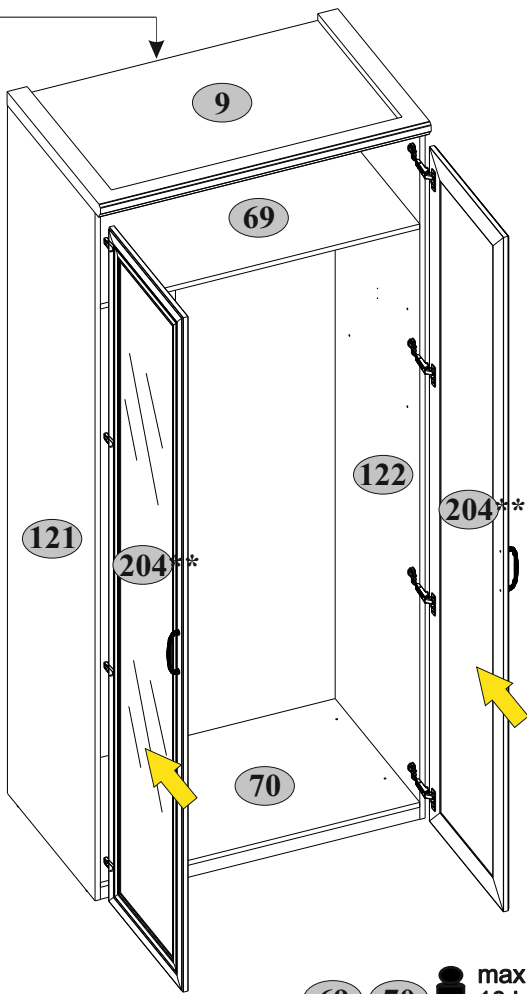
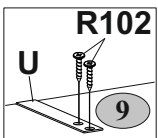
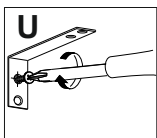
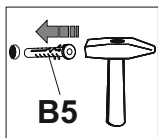
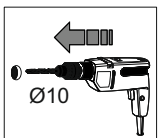
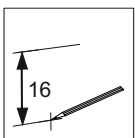
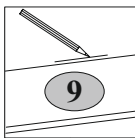

<p>B5</p>  <p>10x50 1</p>	<p>R102</p>  <p>3,5x16 2</p>	<p>U</p>  <p>130x35x15 1</p>
--	---	---



69 70  max. 10 kg

R102  3,5x16	Y1  2
--	---

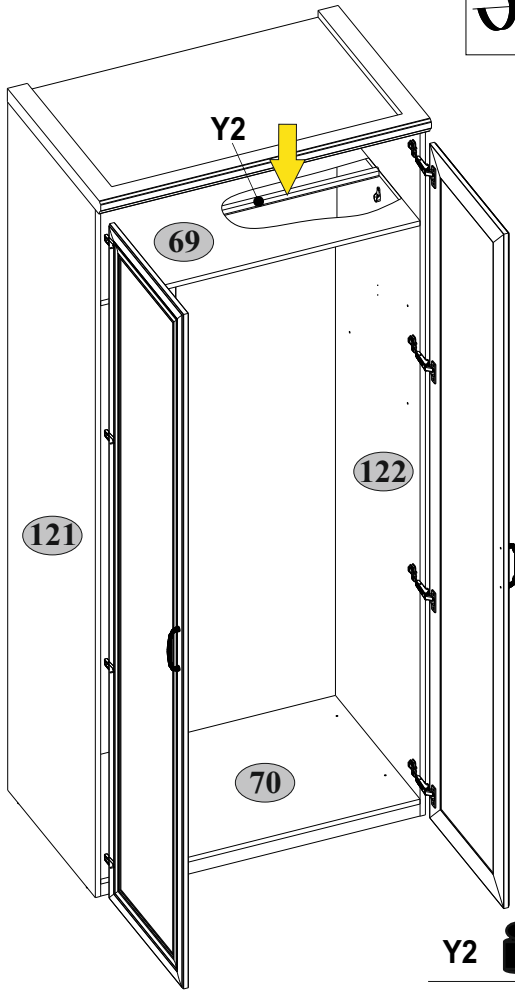
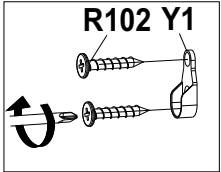
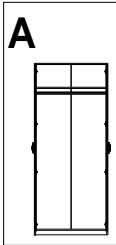

Y2  max. 15 kg

69 **70**  max. 10 kg

21

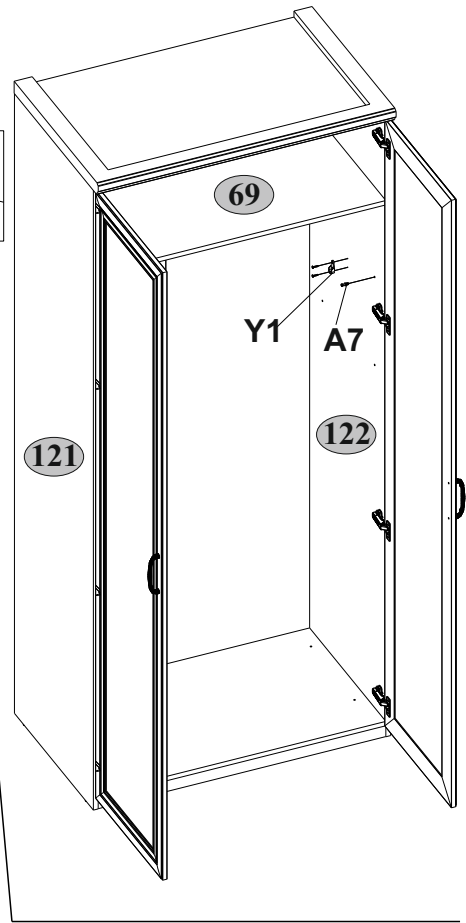
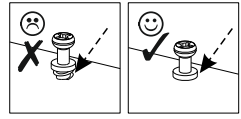
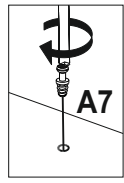
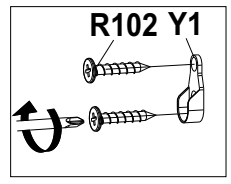
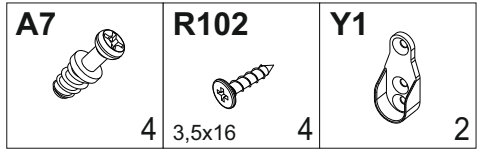
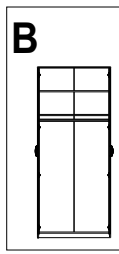

22

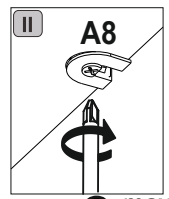
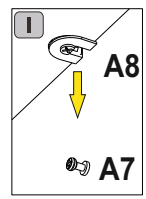
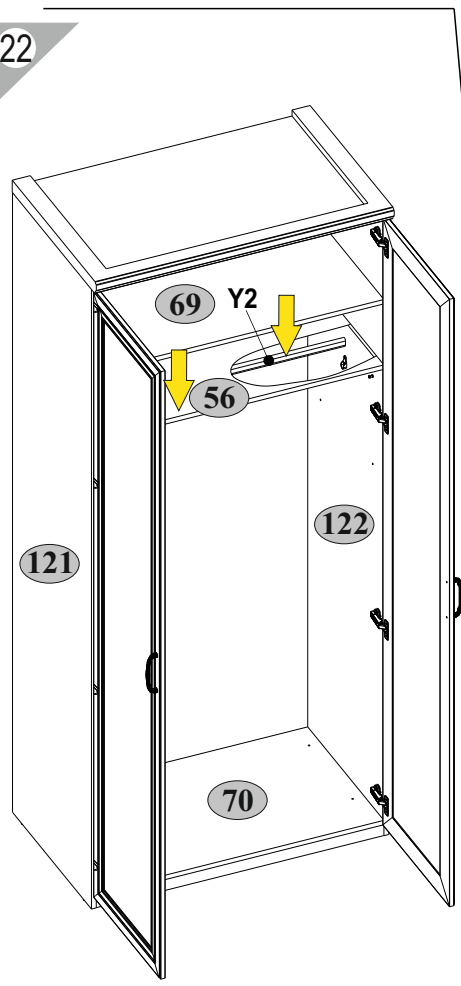



max. 15 kg

max. 10 kg

56 69 70

Элемент для докупки
км0002 д серый Комплект
ящичков к арт. км0009

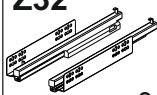
A8  20x13 8	R27  5,0x13 24	Z32  450 3
--	---	---

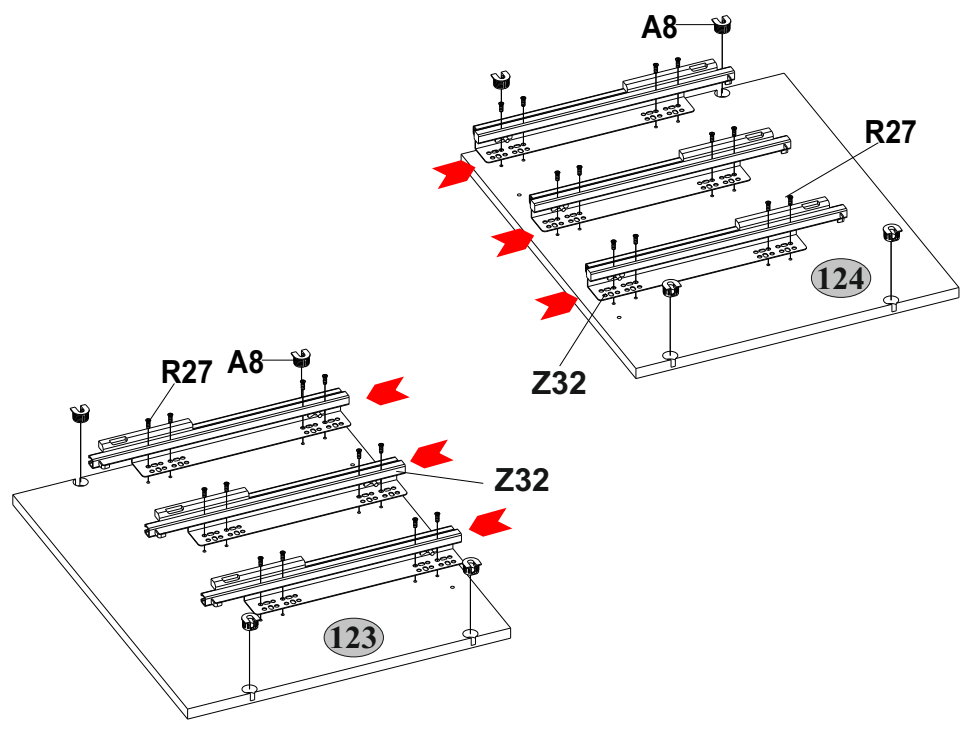
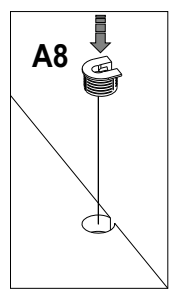
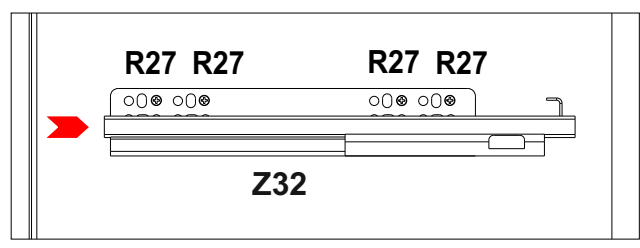

24

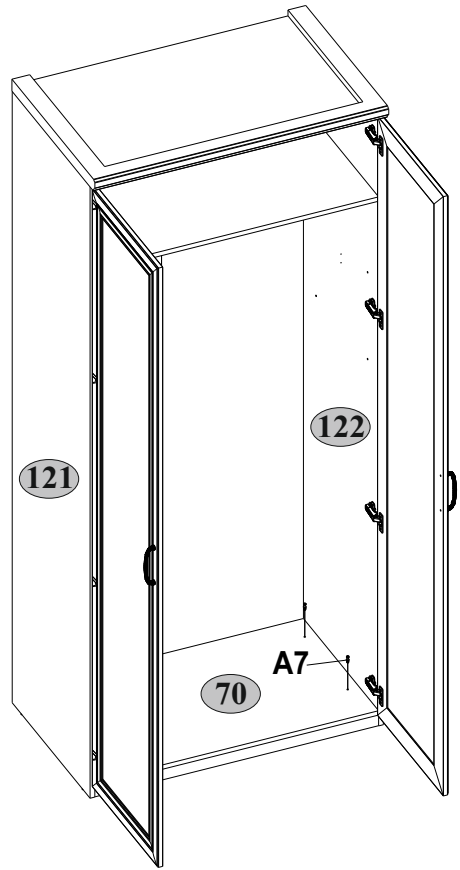
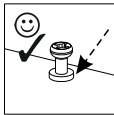
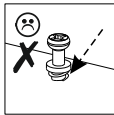
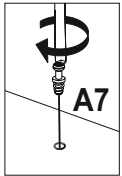
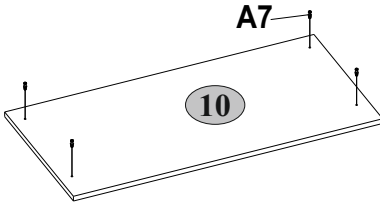
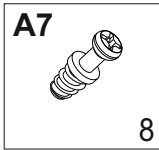

25

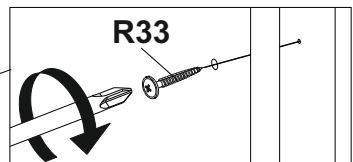
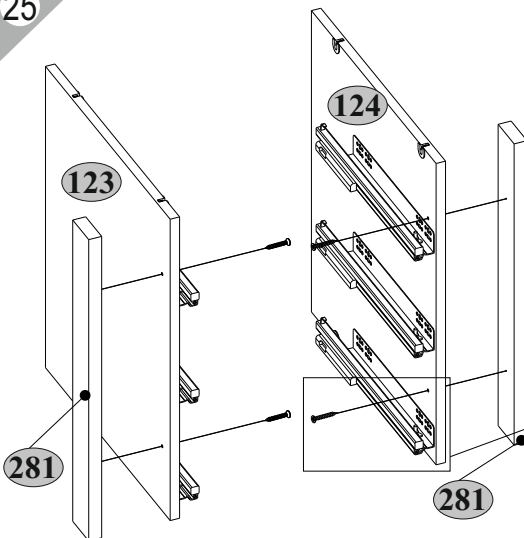
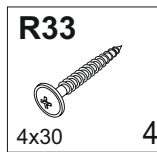



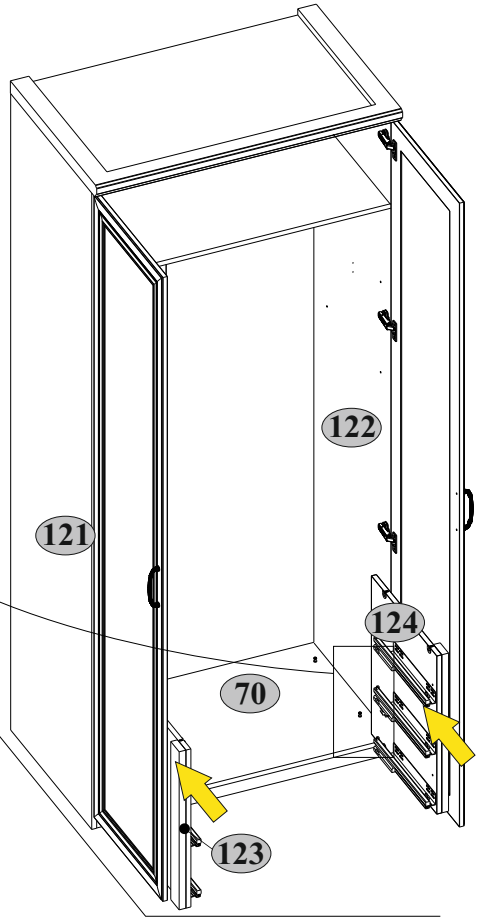
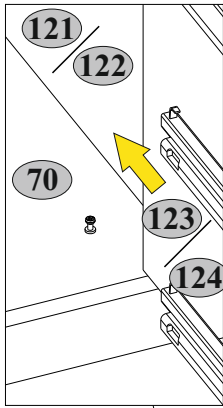

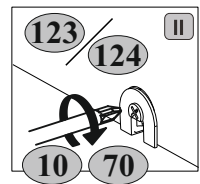
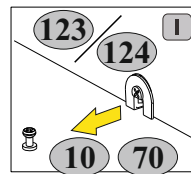
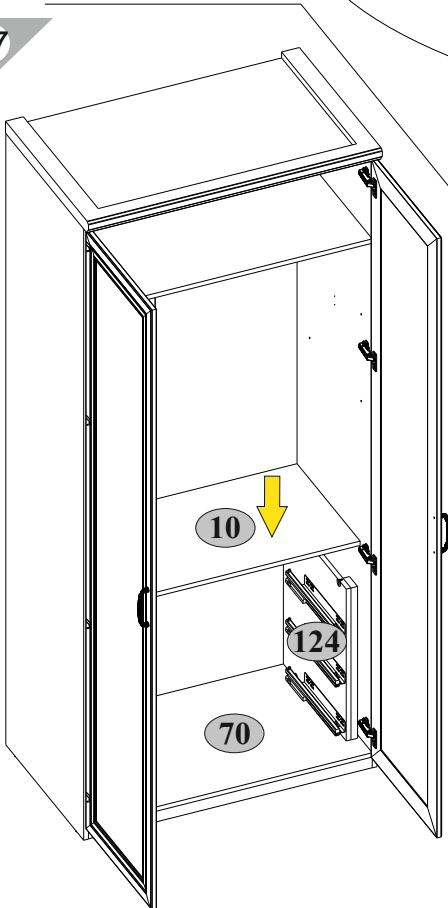

26

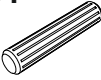

27

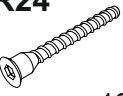

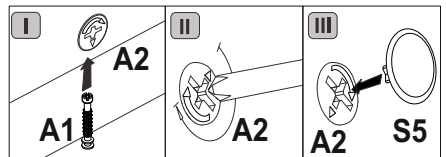
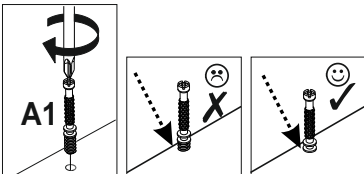
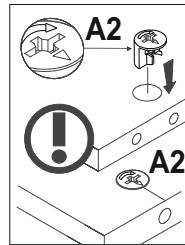
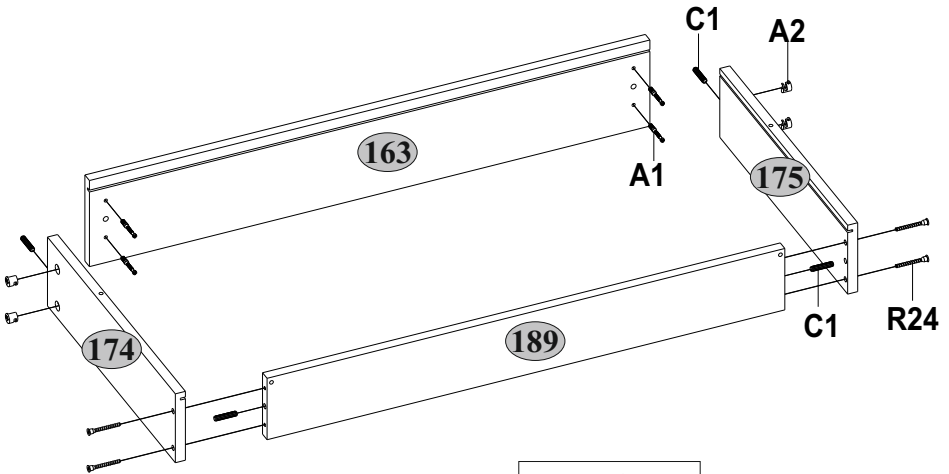
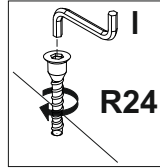
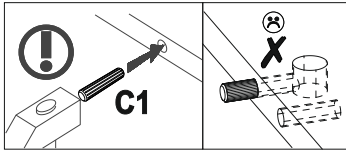

<p>A1</p>  <p>7x34 12</p>	<p>A2</p>  <p>Ø15x12 12</p>	<p>C1</p>  <p>8x35 12</p>	<p>I</p>  <p>S4 1</p>	<p>R24</p>  <p>7x50 12</p>
<p>S5</p>  <p>Ø18 12</p>				

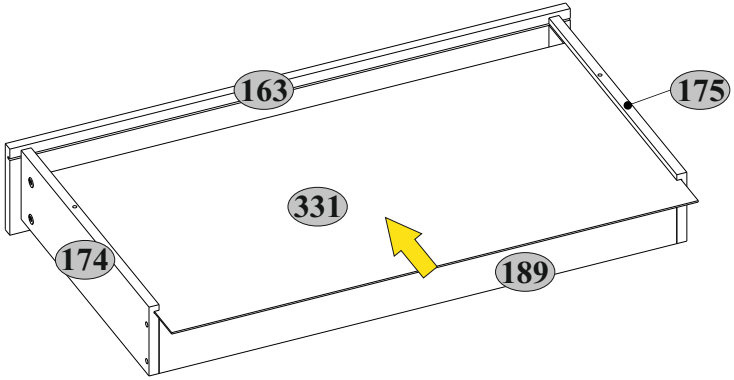

29
x3



30
x3

L5  450 3	R3  3x20 12	R102  3,5x16 6
---	---	--

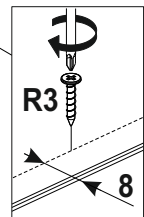
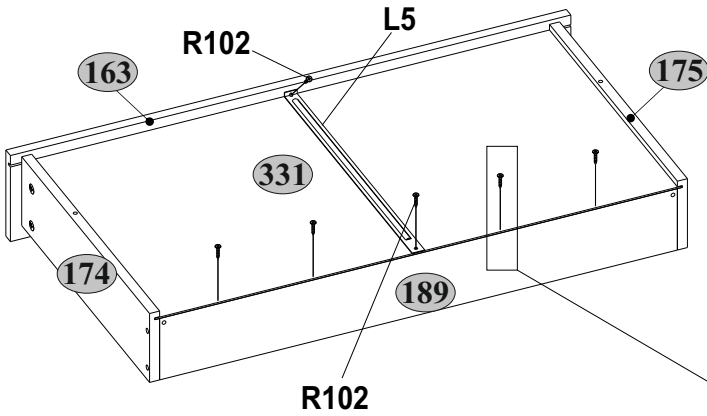
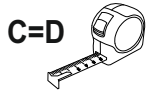
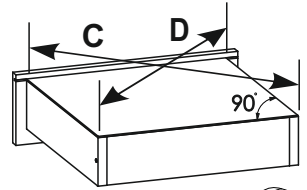

R3



3x20

6

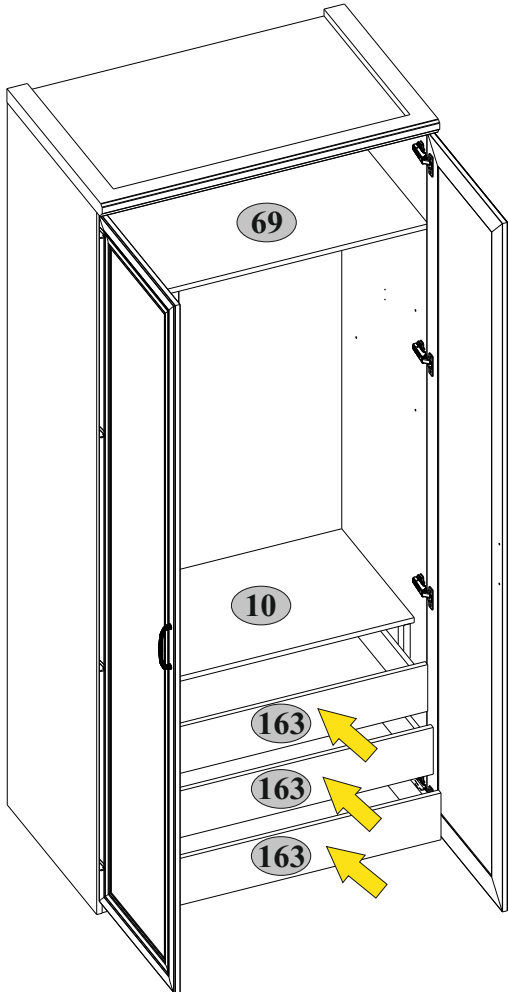
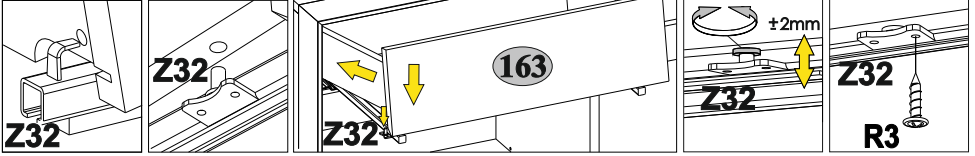

163  max.
5 kg

69 **10**  max.
10 kg

R102



3,5x16

4

Y1



2

A

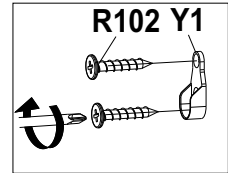
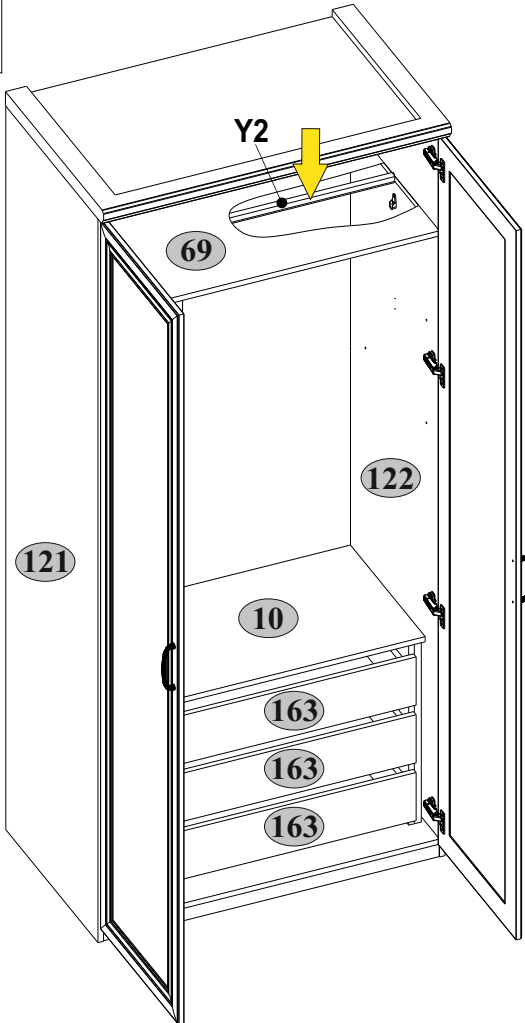
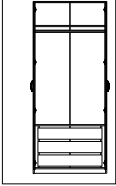

Y2  max.
15 kg

163  max.
5 kg

69  max.
10 kg

33

B

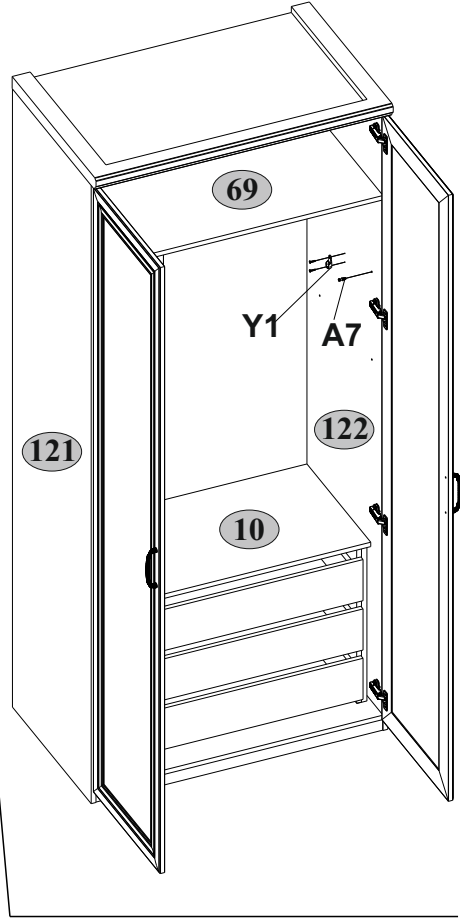
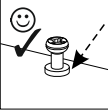
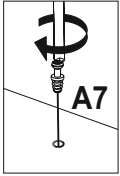
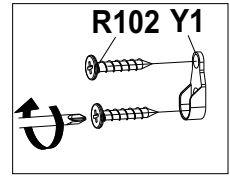
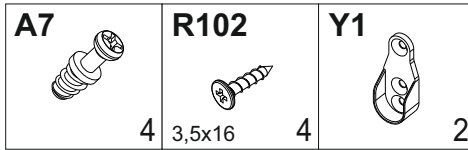

34

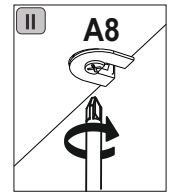
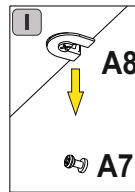
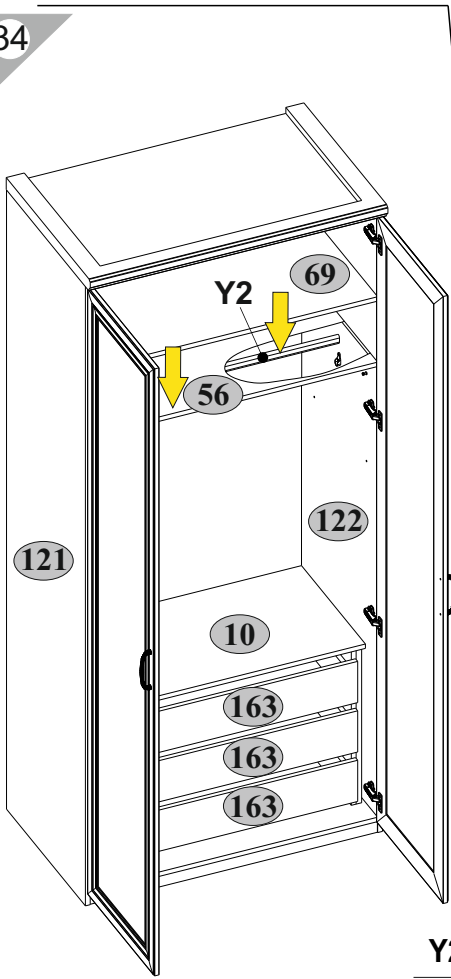

163  max. 5 kg

Y2  max. 15 kg

56 **69** **10**  max. 10 kg

35

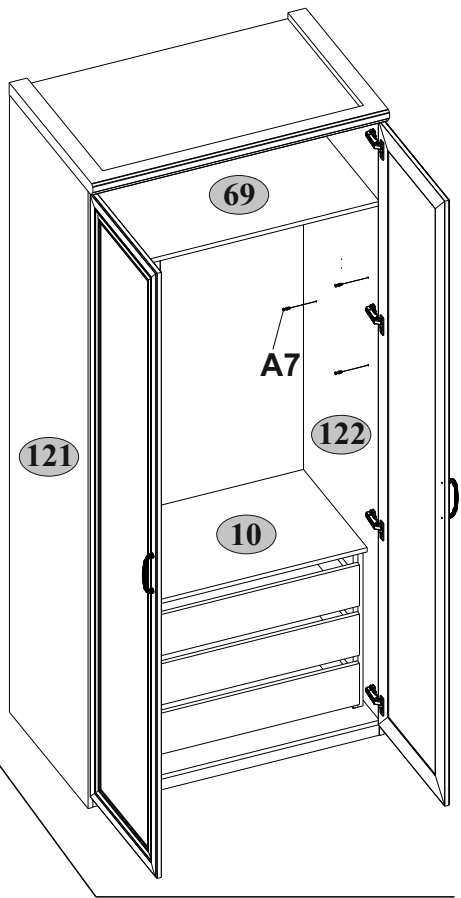
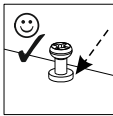
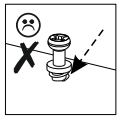
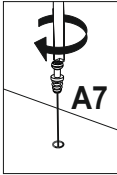
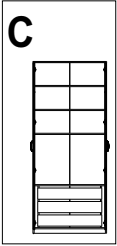
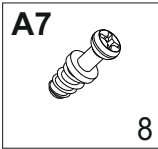

36

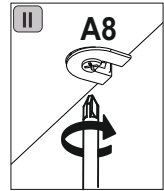
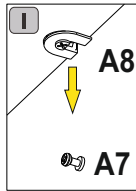
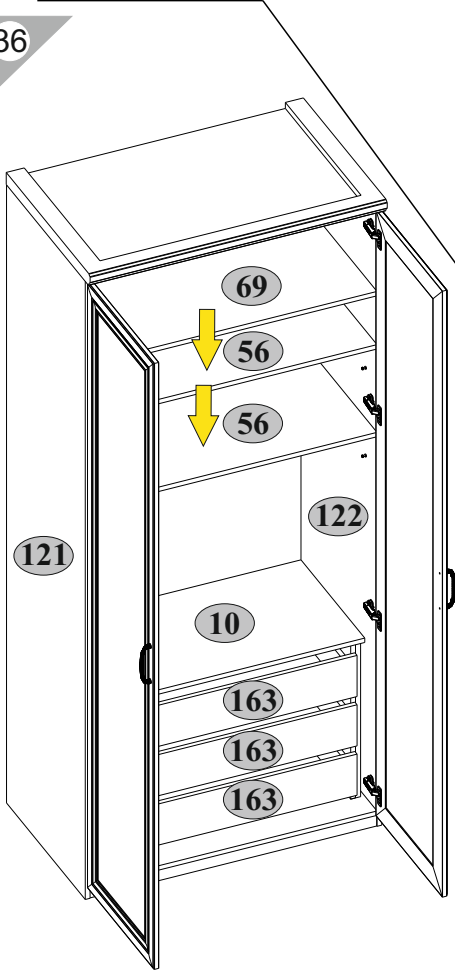

163 max. 5 kg

56 69 10 max. 10 kg



Инструкция по уходу за мебелью и правила эксплуатации

1. Мебель рекомендуется эксплуатировать в бытовых помещениях с температурой воздуха не ниже +2°C и относительной влажностью 45-70 %.
2. Мебель должна быть защищена от воздействия прямых солнечных лучей, так как это вредит внешнему виду изделий и может изменить цвет поверхности.
3. Не следует ставить на поверхность мебели горячие предметы.
4. Случайно попавшую на поверхность изделия влагу, жидкость следует снять сухой тканью.
5. Удаление пыли с полированной или лакированной поверхности следует производить сухой тканью (фланель, миткаль).
6. Полированные и лакированные поверхности мебели рекомендуется освежать специально предназначенными для этого средствами.
7. Очищать стекла рекомендуется специальными составами, нанесенными на мягкую ткань.
8. Не допускается применение соды, стиральных порошков, абразивных паст, порошков и прочих, не предназначенных для ухода за изделиями мебели препаратов.

Гарантии изготовителя

1. Гарантийный срок эксплуатации изделия - 36 месяцев со дня продажи магазином. В период гарантийного срока изготовитель гарантирует ремонт изделий или их замену, если потребителем не нарушены правила эксплуатации.
2. Претензии предъявляются потребителем непосредственно в торгующую организацию, в которой была приобретена мебель, предъявив настоящую "Инструкцию по сборке" и копию товарного чека.
3. Изделие соответствует требованиям [REDACTED]
4. Срок службы мебели - 5 лет.
5. Предприятие-изготовитель оставляет за собой право вносить изменения в конструкцию изделия, не ухудшая его конструктивные и эксплуатационные характеристики.
6. Для сборки изделий рекомендуется привлекать квалифицированных специалистов.

Запах.

От новой мебели может исходить запах материалов, из которых она изготовлена. Запах может сохраняться в течение трёх недель с момента сборки. Для снижения интенсивности запаха рекомендуется:

-для мягкой мебели - пропылесосить изделие и проветрить помещение.

Повторять 3-4 раза в день.

-для корпусной мебели – протирать тканью, смоченной мягким моющим средством, вытирать чистой сухой тканью и проветривать помещение, предварительно открывая все двери и ящики изделия.

Повторять 3-4 раза в день.

Важно! Сохраните, пожалуйста, инструкцию в случае повторной сборки мебели или рекламации. В случае составления рекламации пользуйтесь, пожалуйста, обозначением из инструкции сборки.