

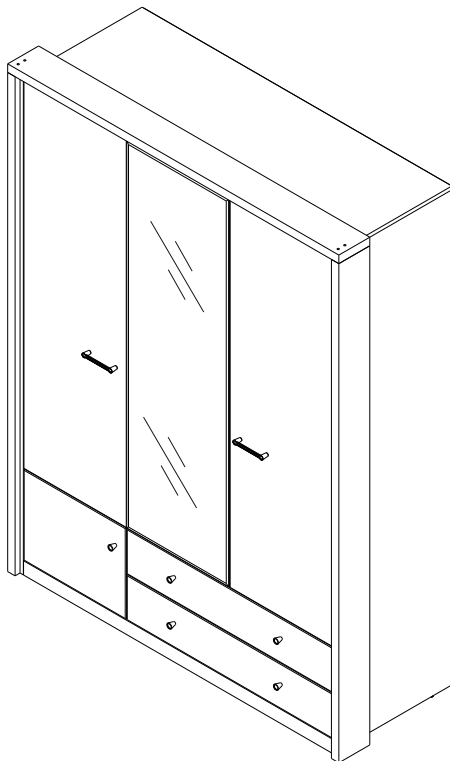

инструкция по сборке
Набор мебели для общей комнаты
«Дениз»

4890 дз дуб веллингтон черный
Шкаф трехстворчатый



габаритные размеры:

высота — 2132 мм
ширина — 1600 мм
глубина — 603 мм

Дата выпуска





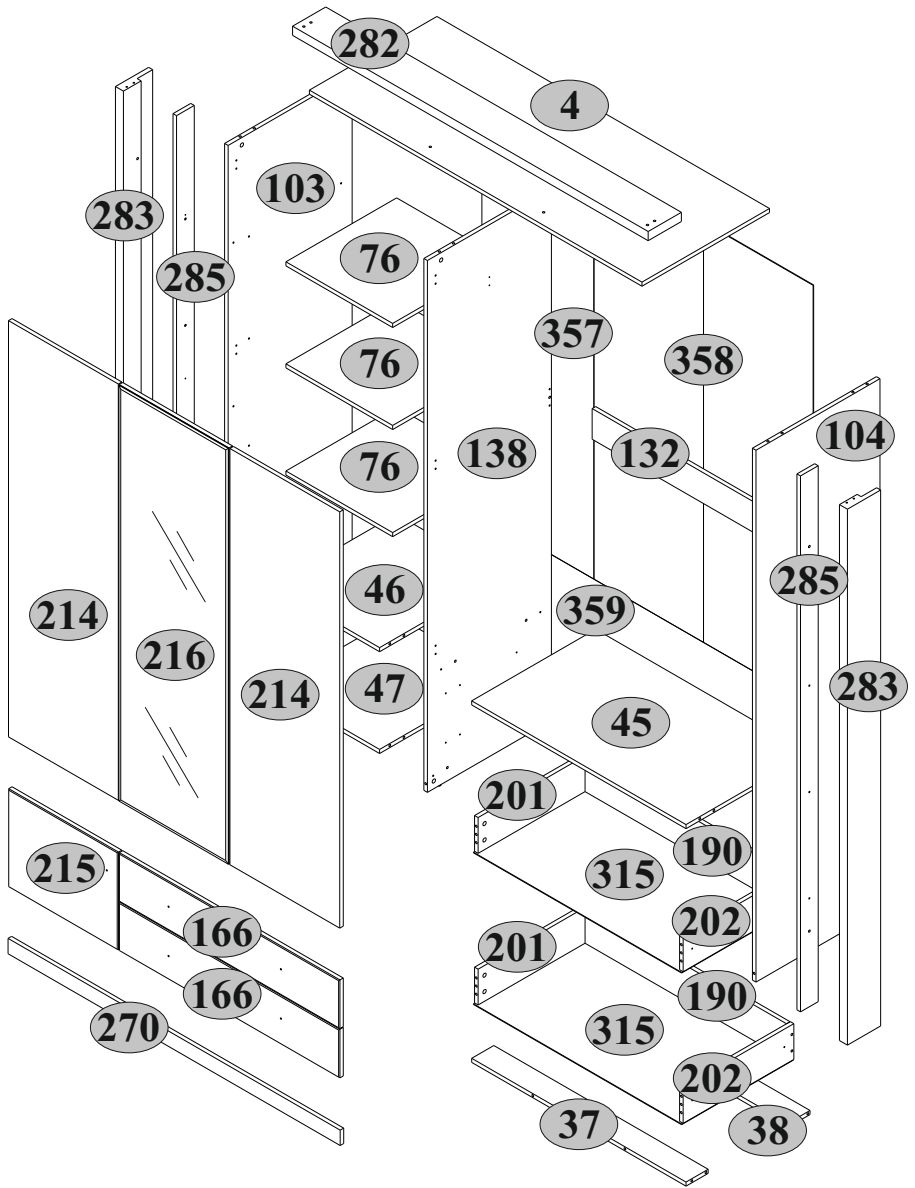



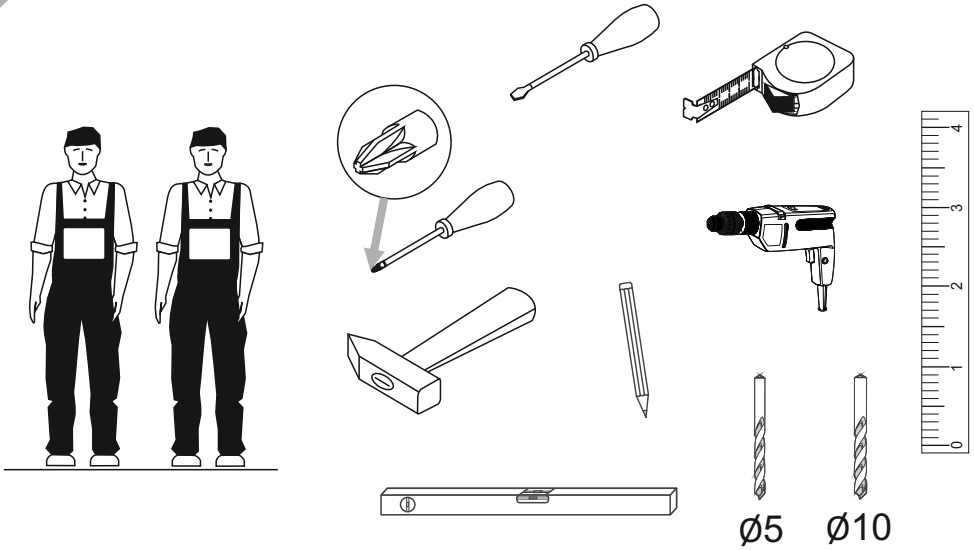



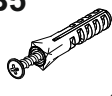
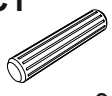

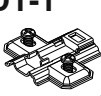
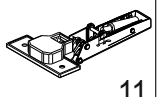

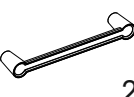

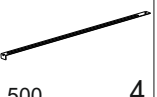

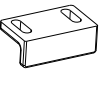

единая справочная служба:
8 800 100-50-22
(звонок по России бесплатный)

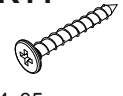
LAZURIT МЕБЕЛЬ

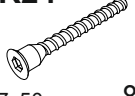
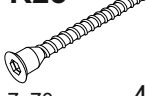

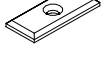





| № п/п | Наименование | Длина мм | Ширина мм | Толщина мм | Кол-во шт. | № пачки |
|-------|----------------------------------|-------------|--------------|---------------|---------------|------------|
| 4 | Щит верхний | 1502 | 576 | 16 | 1 | 1/5 |
| 37 | Брусok горизонтальный передний | 968 | 100 | 16 | 1 | 1/5 |
| 38 | Брусok горизонтальный задний | 968 | 100 | 16 | 1 | 1/5 |
| 45 | Полка соединительная средняя | 968 | 560 | 16 | 1 | 1/5 |
| 46 | Полка соединительная верхняя | 484 | 560 | 16 | 1 | 1/5 |
| 47 | Полка соединительная нижняя | 484 | 560 | 16 | 1 | 1/5 |
| 76 | Полка переставная | 482 | 500 | 16 | 3 | 1/5 |
| 103 | Стенка боковая левая | 2080 | 560 | 16 | 1 | 2/5 |
| 104 | Стенка боковая правая | 2080 | 560 | 16 | 1 | 2/5 |
| 132 | Планка горизонтальная | 968 | 120 | 16 | 1 | 1/5 |
| 138 | Перегородка | 2080 | 560 | 16 | 1 | 2/5 |
| 166 | Панель передняя ящика | 996 | 190 | 16 | 2 | 1/5 |
| 190 | Стенка задняя ящика | 910 | 140 | 16 | 2 | 4/5 |
| 201 | Стенка боковая ящика левая | 500 | 140 | 16 | 2 | 4/5 |
| 202 | Стенка боковая ящика правая | 500 | 140 | 16 | 2 | 4/5 |
| 214 | Дверь | 1628 | 496 | 16 | 2 | 3/5 |
| 215 | Дверь малая | 496 | 383 | 16 | 1 | 1/5 |
| 216 | Дверь с зеркалом | 1628 | 496 | 20 | 1 | 3/5 |
| 270 | Царга | 1500 | 60 | 16 | 1 | 1/5 |
| 282 | Обкладка горизонтальная | 1600 | 150 | 32 | 1 | 4/5 |
| 283 | Обкладка вертикальная внешняя | 2096 | 150 | 32 | 2 | 4/5 |
| 285 | Обкладка вертикальная внутренняя | 2096 | 80 | 16 | 2 | 4/5 |
| 315 | Дно ящика | 940 | 505 | 2,5 | 2 | 5/5 |
| 357 | Стенка задняя верхняя левая | 1644 | 506 | 2,5 | 1 | 5/5 |
| 358 | Стенка задняя верхняя правая | 1644 | 990 | 2,5 | 1 | 5/5 |
| 359 | Стенка задняя нижняя | 1496 | 404 | 2,5 | 1 | 5/5 |
| У2 | Штанга | 962 | | | 1 | 1/5 |
| | Комплект фурнитуры | | | | 1 | 1/5 |

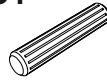
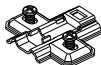





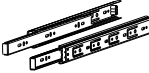

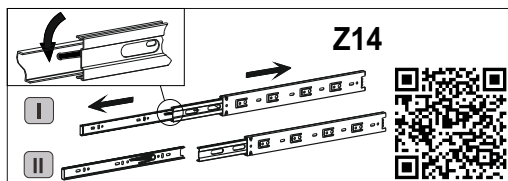
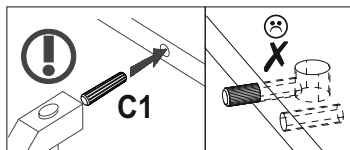
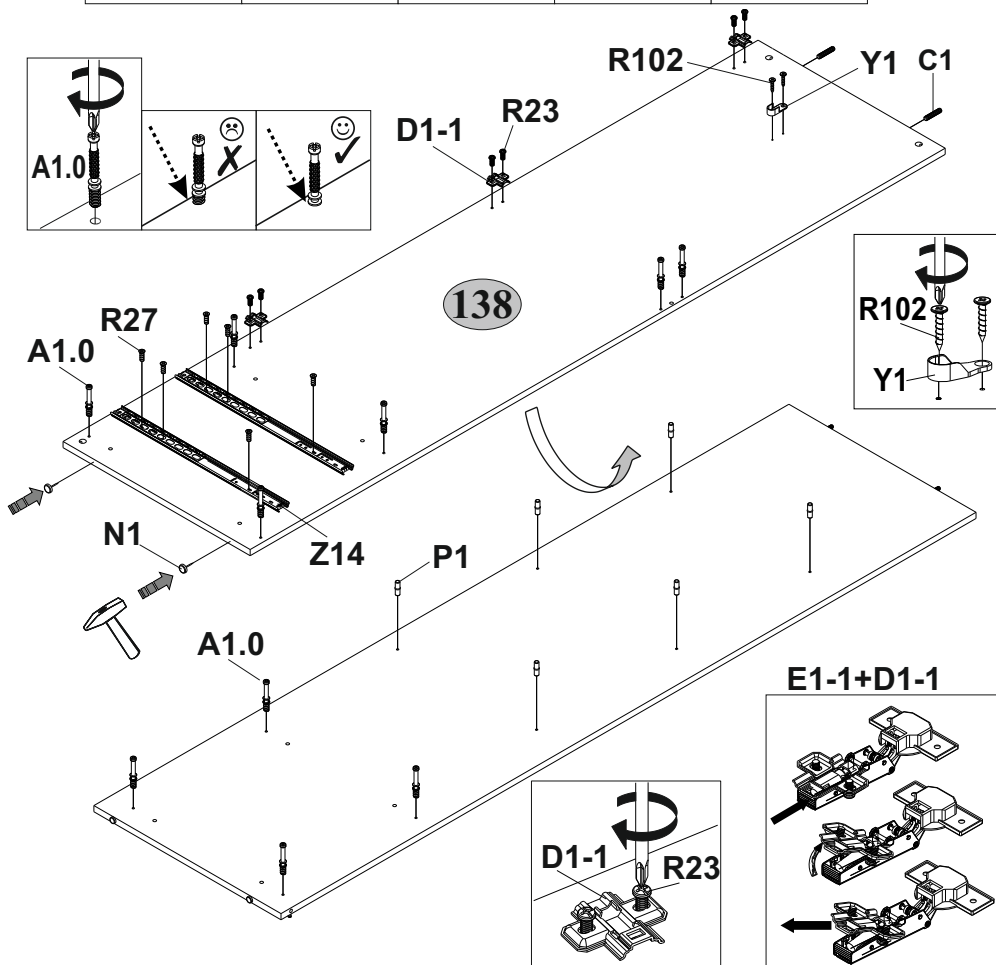
| | | | | | |
|---|---|--|---|---|--|
| A1.0  5x28 37 | A2  Ø15x13 37 | B5  10x50 2 | C1  8x35 34 | C6  8x24 6 | D1-1  11 |
| E1-1  11 | G  1,5x26 60 | H27  2 | H30  5 | I  S4 1 | L2  500 4 |
| M4  M4x22 9 | N1  6 | P1  Ø5 12 | Q  1,5x7 7 | Q4  2 | R3  3x20 29 |
| R10  4x30 9 | R11  4x35 8 | R23  6,3x13 22 | R24  7x50 8 | R25  7x70 4 | R27  5,0x13 24 |
| R102  3,5x16 42 | S3  9 | S5  Ø18 14 | U  90x35x15 2 | Y1  2 | Z14  500 2 |

4

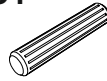
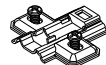
| | | | | |
|---|---|--|---|--|
| A1.0  5x28 10 | C1  8x35 2 | D1-1  3 | N1  2 | P1  ∅5 6 |
| R23  6,3x13 6 | R27  5,0x13 6 | R102  3,5x16 2 | Y1  1 | Z14  500 1 |

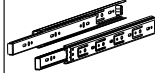

5

| | | | | |
|---|--|---|--|---|
| A1.0  5x28 10 | C1  8x35 4 | D1-1  4 8 | N1  4 Ø5 6 | P1  |
| R23  6,3x13 16 | R27  5,0x13 6 | R102  3,5x16 2 | Y1  1 | Z14  500 1 |

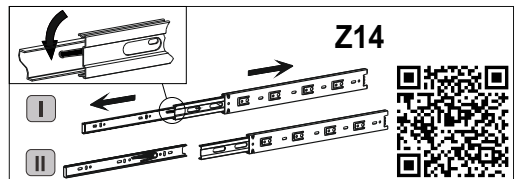
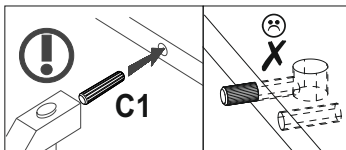
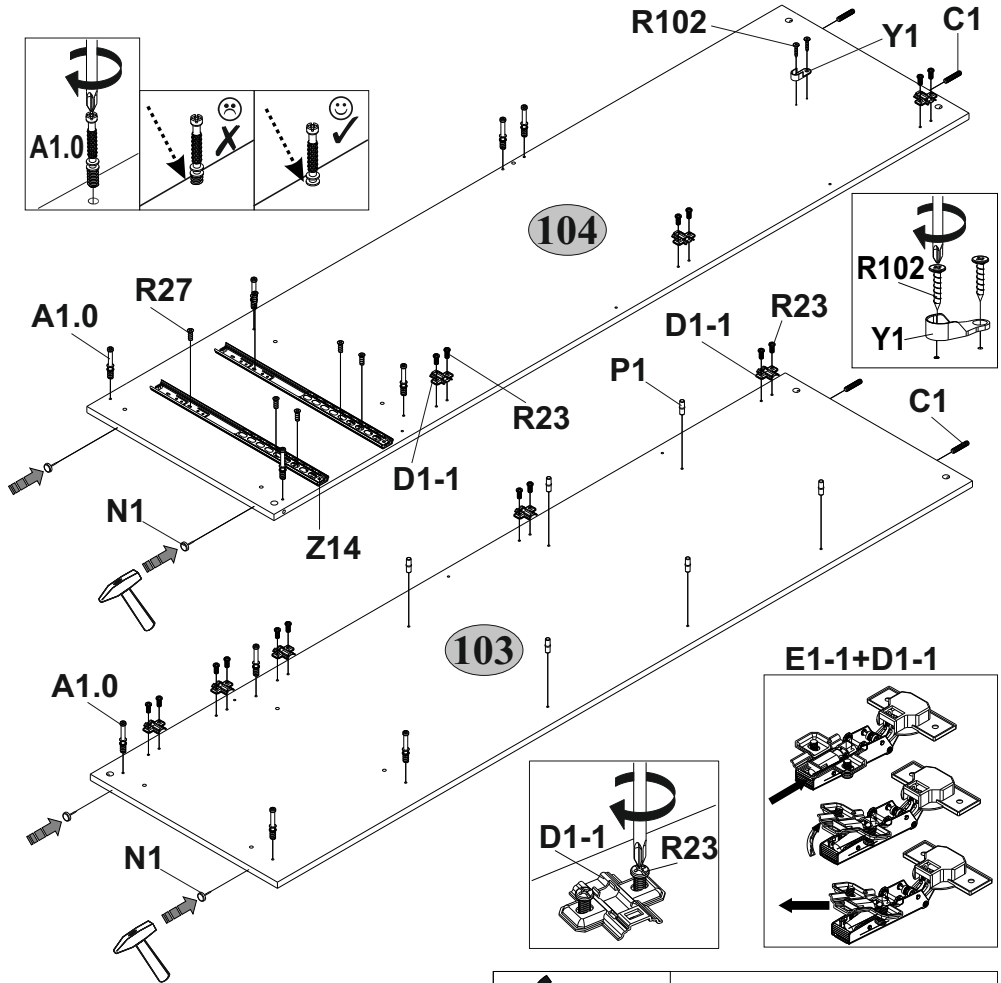
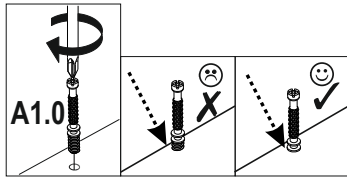

6

C1

8x35

12

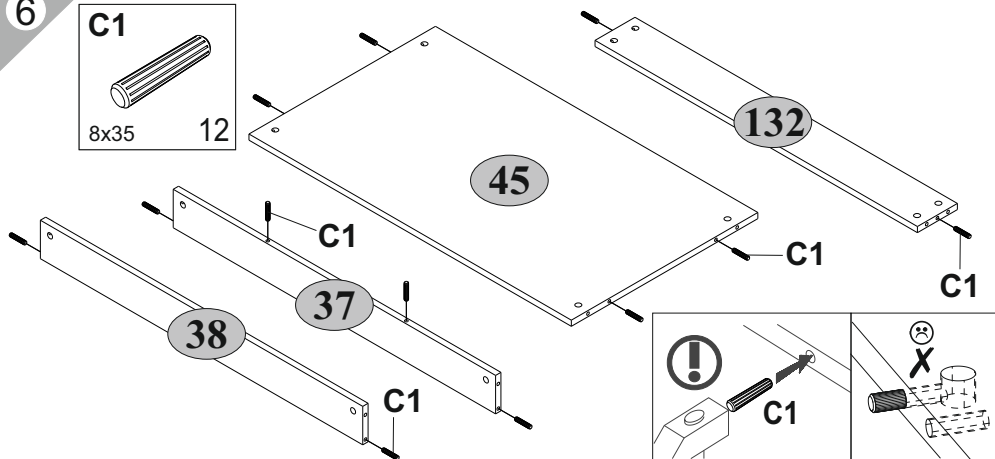

7

A2

Ø15x13

12

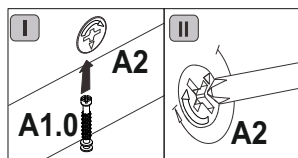
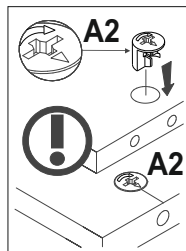
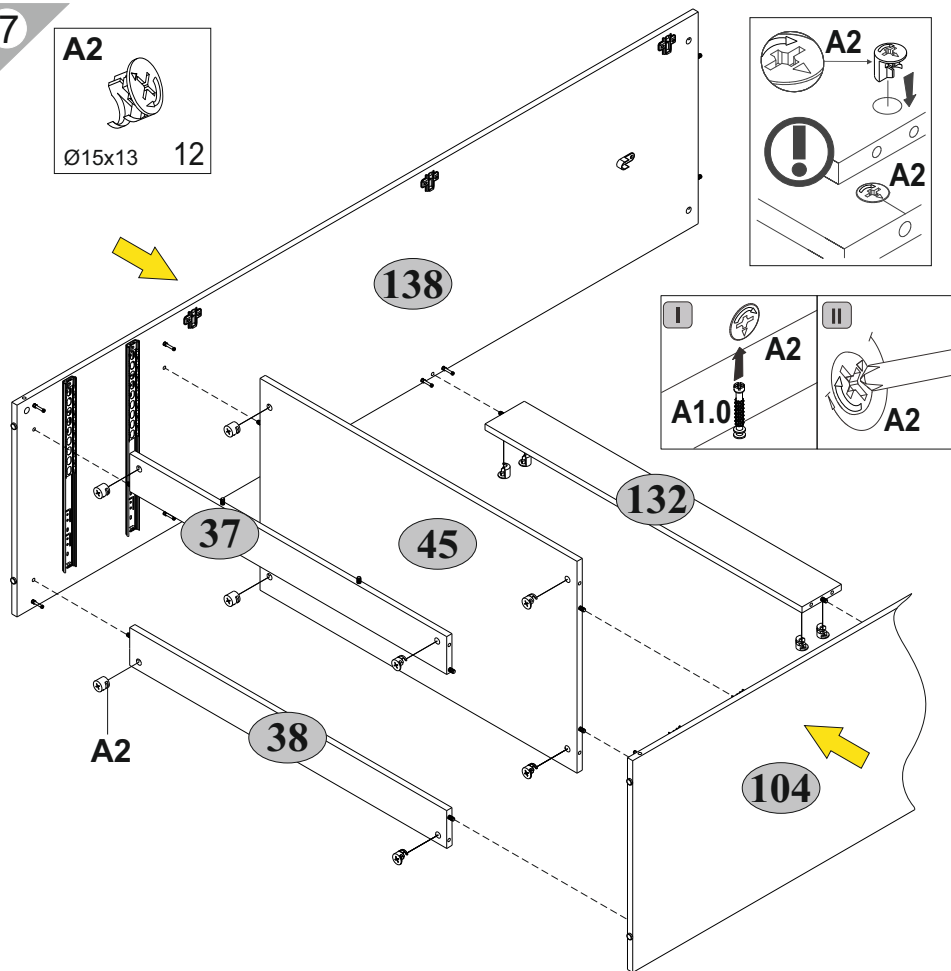

8

C1

8x35

8

C1

46

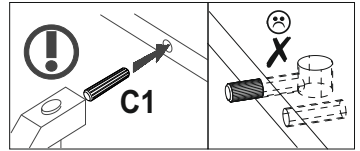

C1

47

9

A2

Ø15x13

8

103

46



138

47

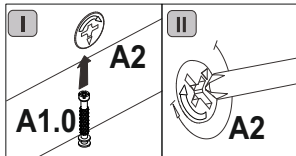
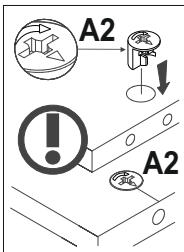
A2

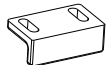

10

| | | |
|---|---|---|
| A1.0  5x28 6 | Q4  2 | R102  3,5x16 4 |
|---|---|---|

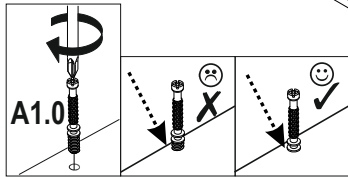
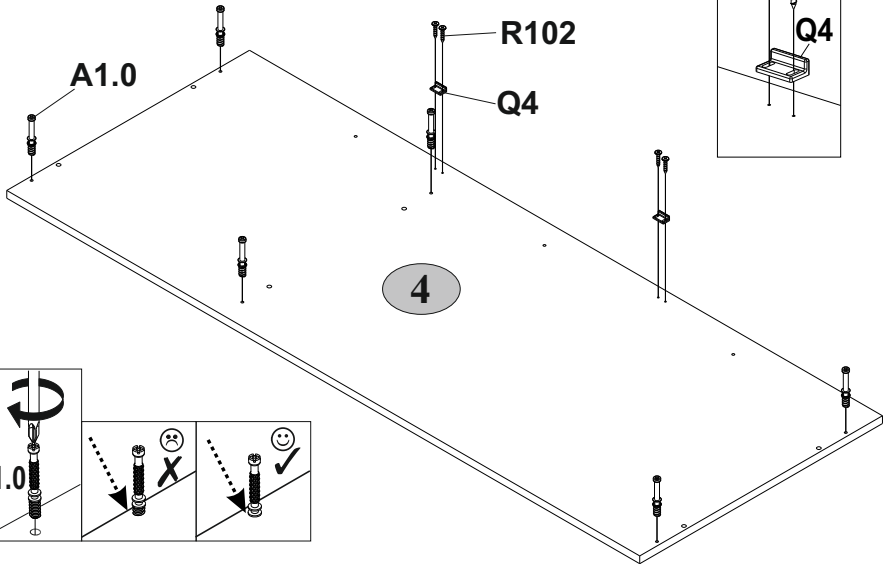
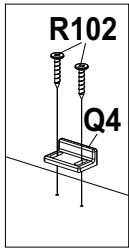

11

| |
|---|
| A2  Ø15x13 6 |
|---|

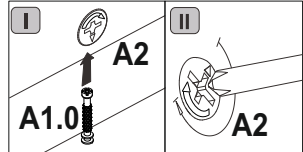
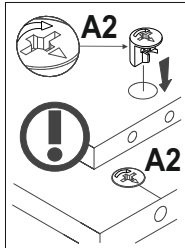
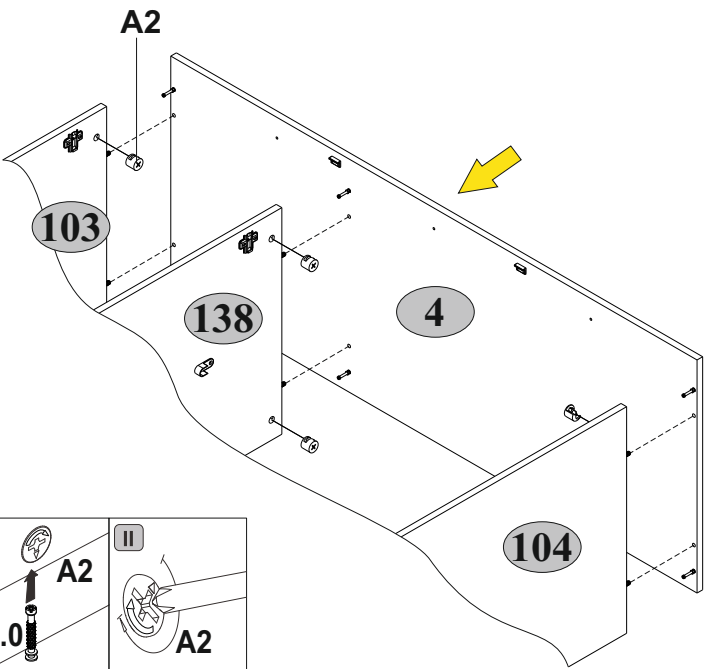

12

A1.0

5x28

3

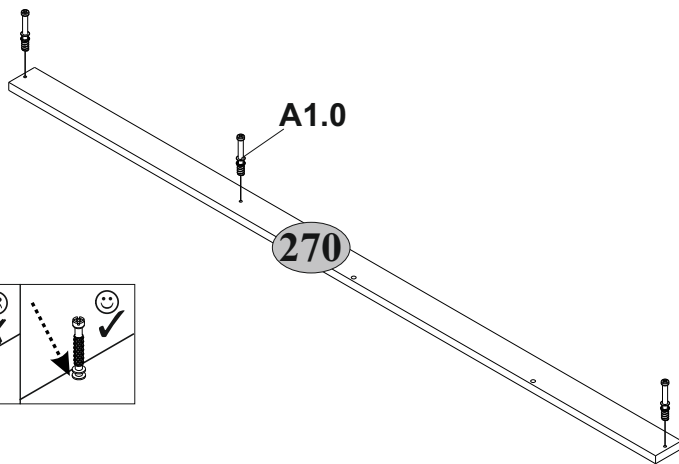
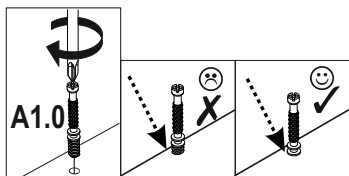

13



A2

Ø15x13

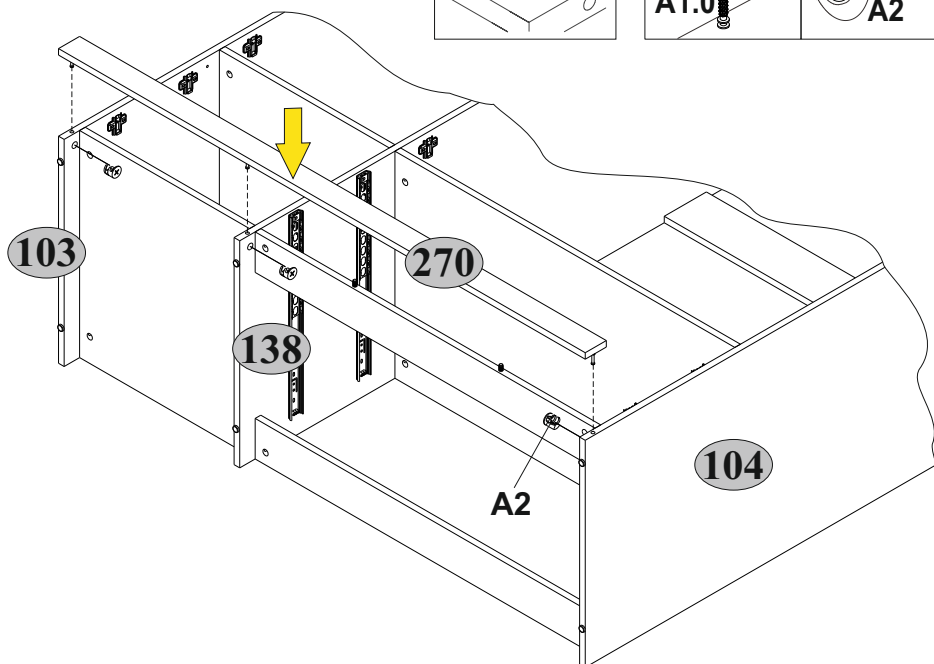
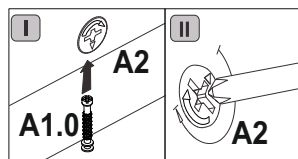
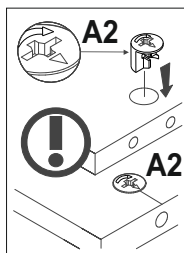

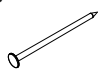

3

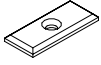

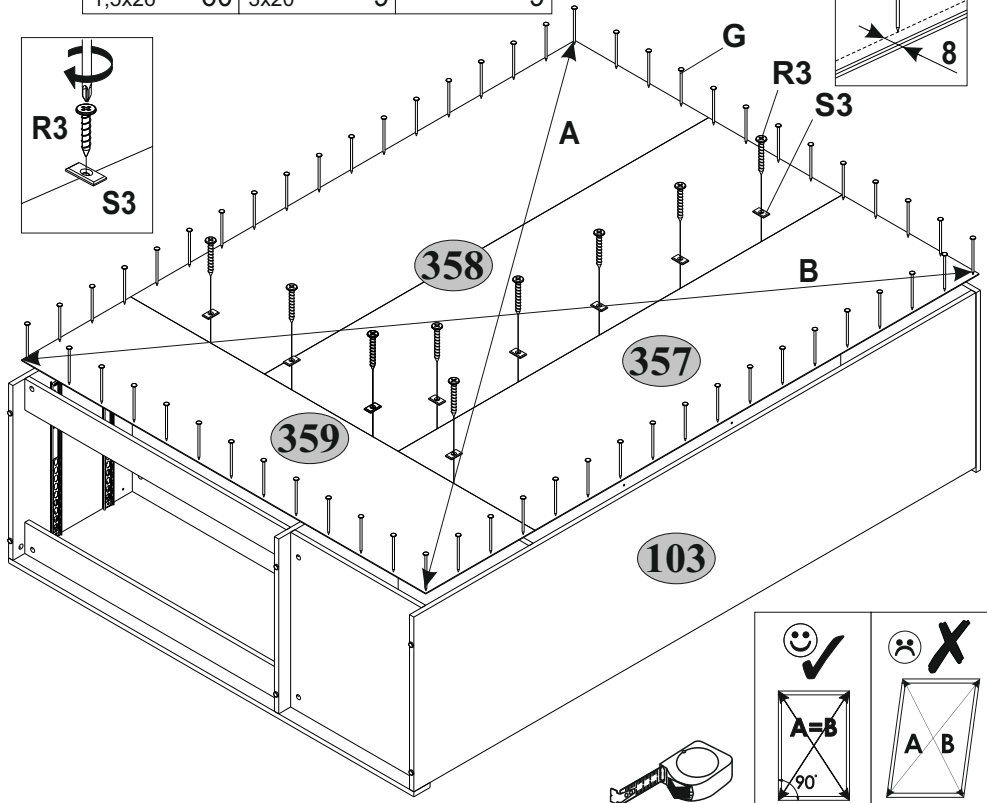
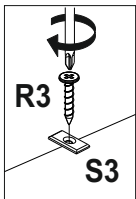
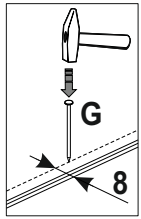
14

| | | |
|---|---|---|
| G  1,5x26 60 | R3  3x20 9 | S3  9 |
|---|---|---|

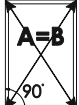

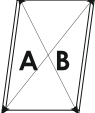
| | |
|--|---|
|    |    |
|--|---|

15

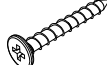

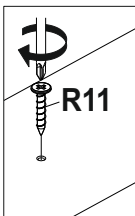
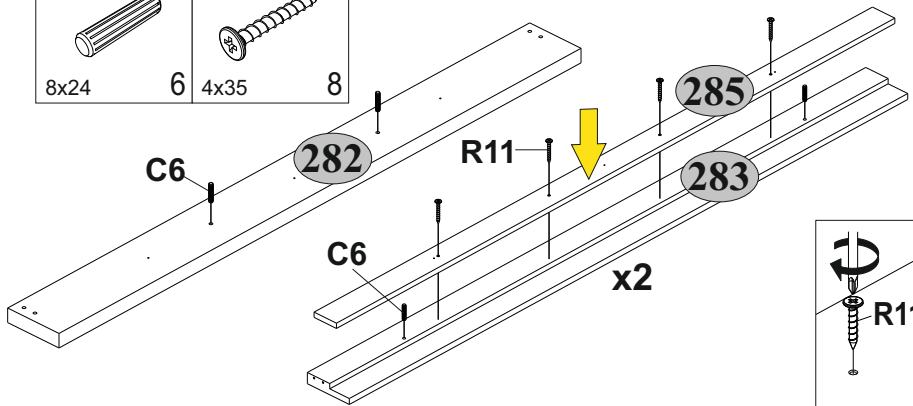

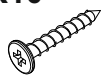
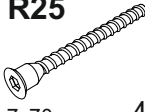
| | |
|---|--|
| C6  8x24 6 | R11  4x35 8 |
|---|--|

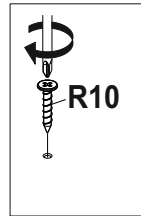
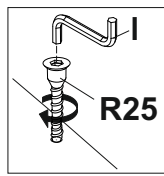
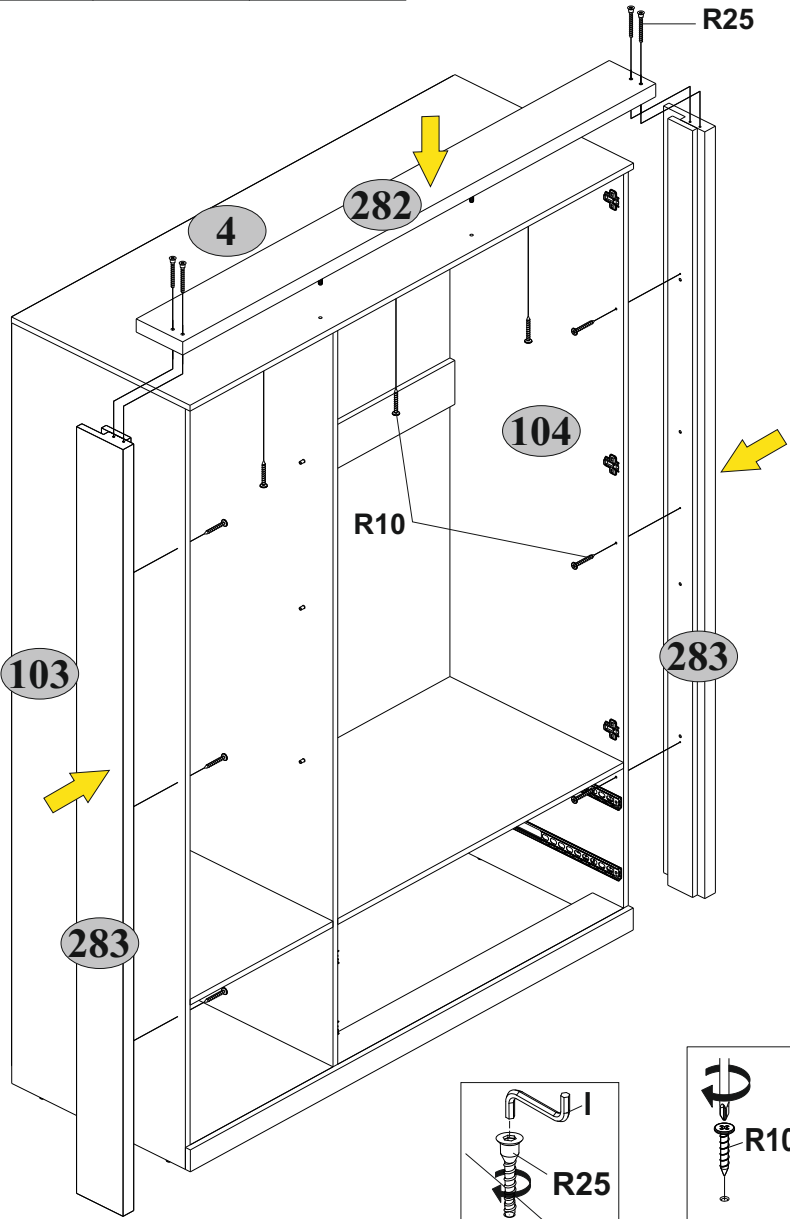

| | | |
|--|--|--|
| I  S4 1 | R10  4x30 9 | R25  7x70 4 |
|--|--|--|

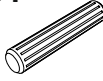

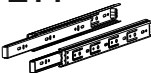

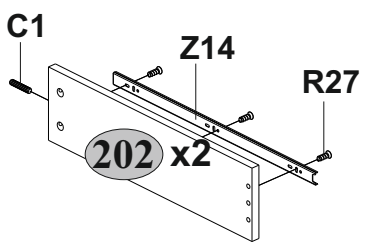
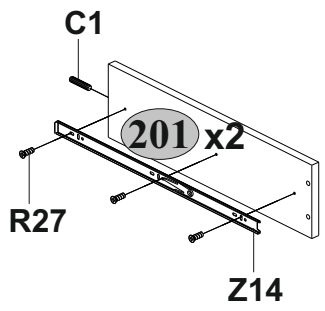
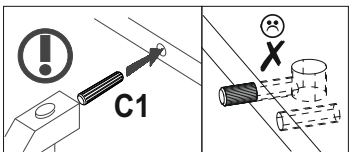

17

| | | | |
|--|--|---|--|
| C1  8x35 | R27  4 | Z14  12 500 | Z14  2 |
|--|--|---|--|

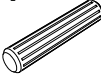

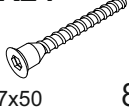

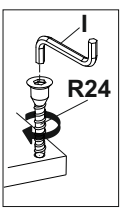
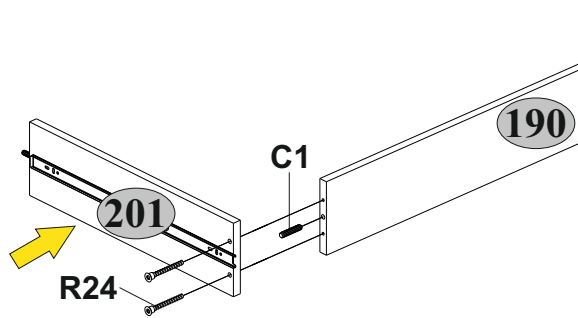
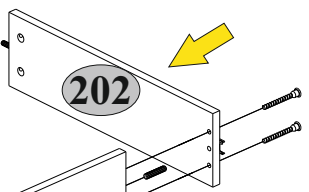

18 x2

| | | | |
|--|---|---|--|
| C1  8x35 | I  S4 | R24  1 7x50 | R24  8 |
|--|---|---|--|



19

| | | | |
|--|--|---|---|
| A1.0  5x28 | H30  8 | M4  4 M4x22 | M4  4 |
|--|--|---|---|

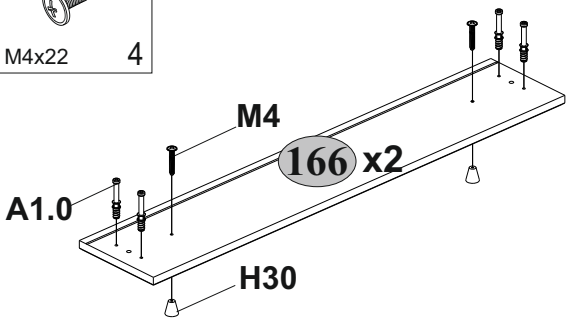
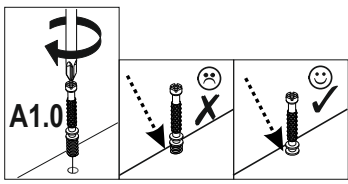



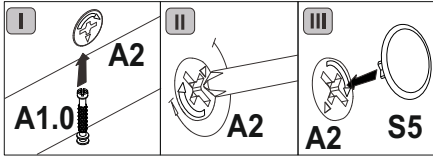
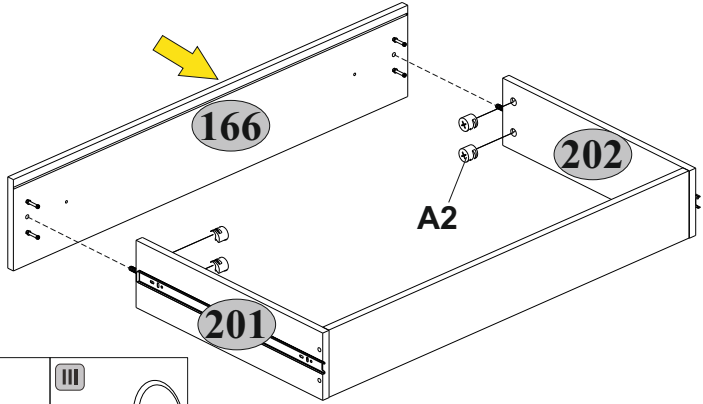
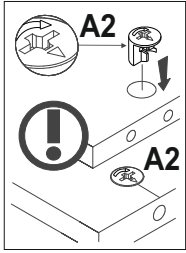
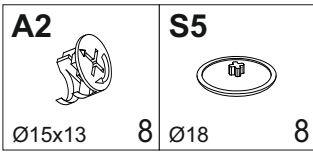

20 x2

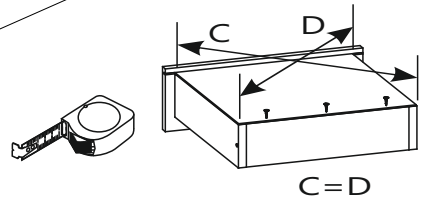
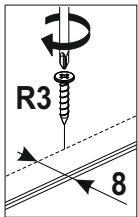
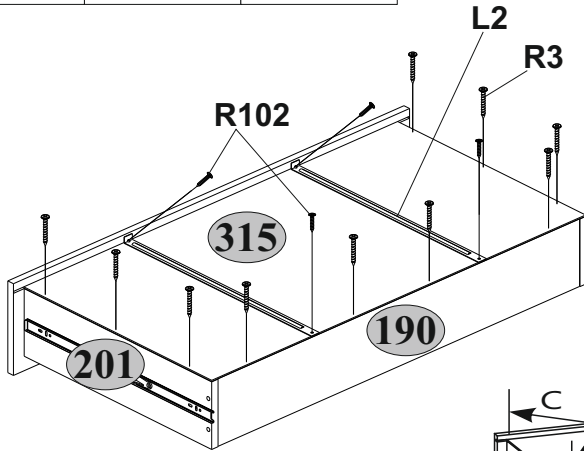
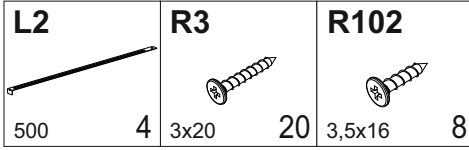

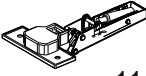



21 x2

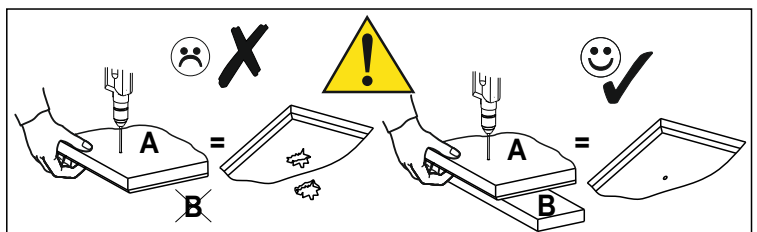
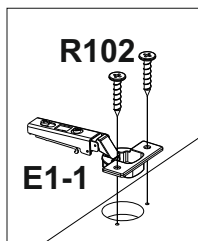
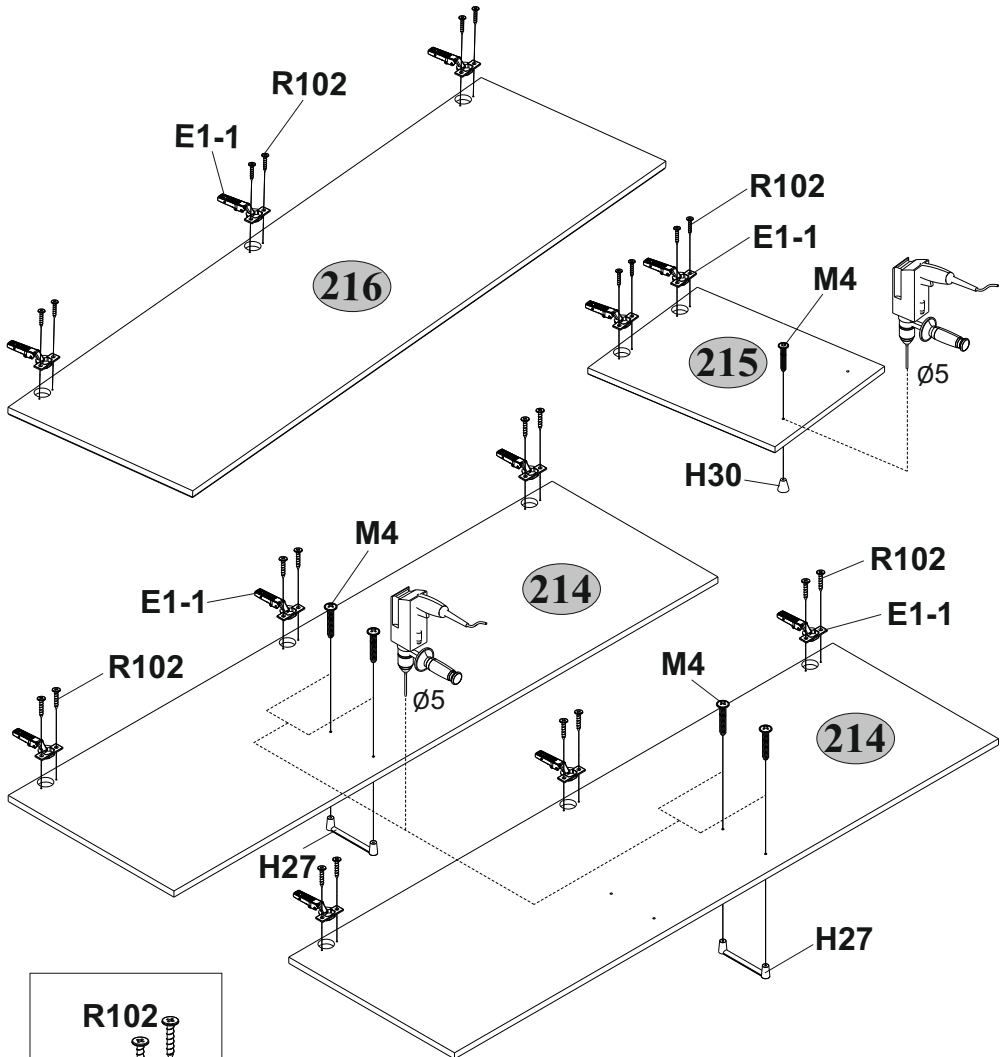

| | | | | |
|--|--|--|---|---|
| E1-1  11 | H27  2 | H30  1 | M4  5 M4x22 | R102  5 3,5x16 22 |
|--|--|--|---|---|

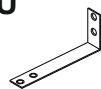

| | | | | |
|--|---|---|--|---|
| B5  10x50 2 | Q  1,5x7 7 | R102  3,5x16 4 | S5  Ø18 6 | U  90x35x15 2 |
|--|---|---|--|---|

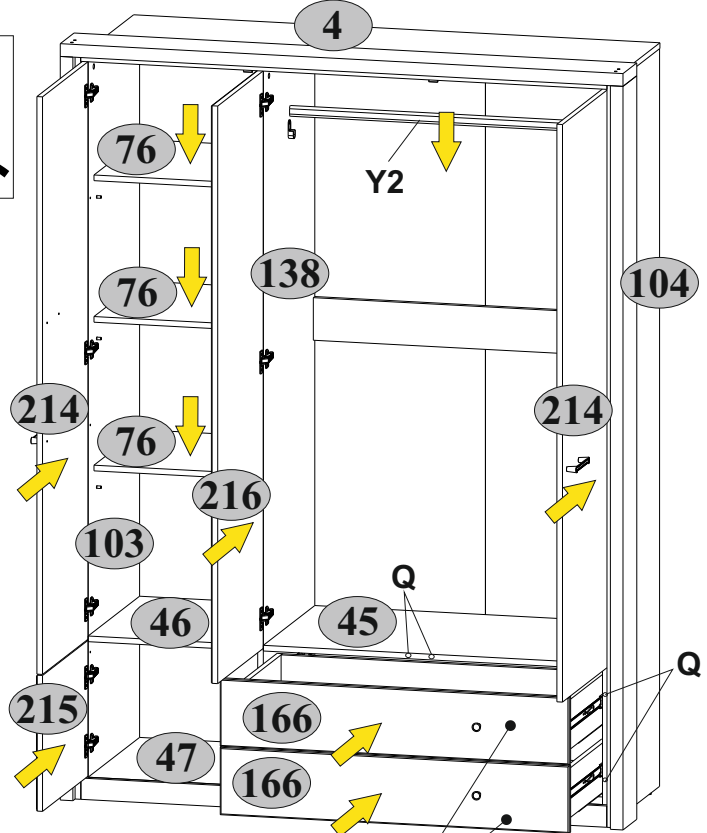
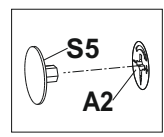
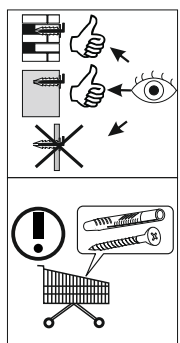
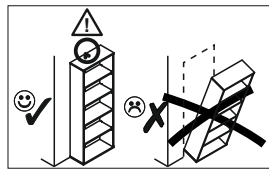
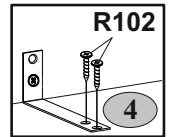
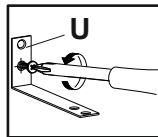
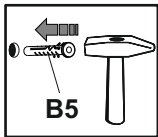
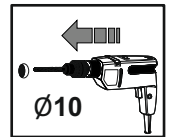
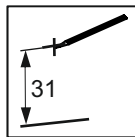
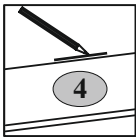

Y2  max. 10 kg

45 46 47 76  max. 5 kg

Q  max. 5 kg

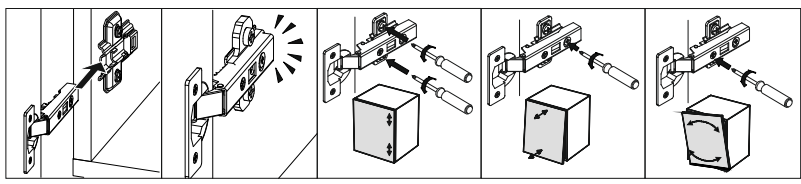



Инструкция по уходу за мебелью и правила эксплуатации

1. Мебель рекомендуется эксплуатировать в бытовых помещениях с температурой воздуха не ниже +2°C и относительной влажностью 45-70 %.
2. Мебель должна быть защищена от воздействия прямых солнечных лучей, так как это вредит внешнему виду изделий и может изменить цвет поверхности.
3. Не следует ставить на поверхность мебели горячие предметы.
4. Случайно попавшую на поверхность изделия влагу, жидкость следует снять сухой тканью.
5. Удаление пыли с полированной или лакированной поверхности следует производить сухой тканью (фланель, миткаль).
6. Полированные и лакированные поверхности мебели рекомендуется освежать специально предназначенными для этого средствами.
7. Очищать стекла рекомендуется специальными составами, нанесенными на мягкую ткань.
8. Не допускается применение соды, стиральных порошков, абразивных паст, порошков и прочих, не предназначенных для ухода за изделиями мебели препаратов.

Гарантии изготовителя

1. Гарантийный срок эксплуатации изделия - 36 месяцев со дня продажи магазином. В период гарантийного срока изготовитель гарантирует ремонт изделий или их замену, если потребителем не нарушены правила эксплуатации.
2. Претензии предъявляются потребителем непосредственно в торгующую организацию, в которой была приобретена мебель, предъявив настоящую "Инструкцию по сборке" и копию товарного чека.
3. Изделие, соответствует требованиям ГОСТ 16371-2014, ТР ТС 025/2012, ЕАЭС № ВУ/112 11.01. ТР025 018.01 00279 от 22.06.2021 по 21.06.2026.
4. Срок службы мебели - 5 лет.
5. Предприятие-изготовитель оставляет за собой право вносить изменения в конструкцию изделия, не ухудшая его конструктивные и эксплуатационные характеристики.
6. Для сборки изделий рекомендуется привлекать квалифицированных специалистов.

Запах.

От новой мебели может исходить запах материалов, из которых она изготовлена. Запах может сохраняться в течение трёх недель с момента сборки. Для снижения интенсивности запаха рекомендуется:

-для мягкой мебели - пропылесосить изделие и проветрить помещение.

Повторять 3-4 раза в день.

-для корпусной мебели – протирать тканью, смоченной мягким моющим средством, вытирать чистой сухой тканью и проветривать помещение, предварительно открывая все двери и ящики изделия.

Повторять 3-4 раза в день.

Важно! Сохраните, пожалуйста, инструкцию в случае повторной сборки мебели или рекламации. В случае составления рекламации пользуйтесь, пожалуйста, обозначением из инструкции сборки.