

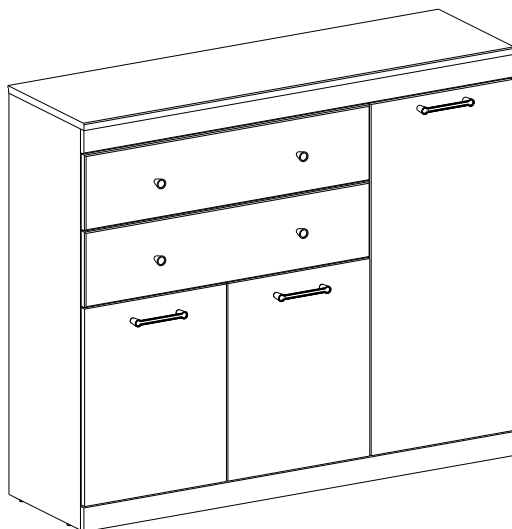

инструкция по сборке  
Набор мебели для общей комнаты  
«Дениз»

**3485 д дуб веллингтон черный**  
**Тумба**



габаритные размеры:

высота — 1028 мм  
ширина — 1202 мм  
глубина — 356 мм

Дата выпуска





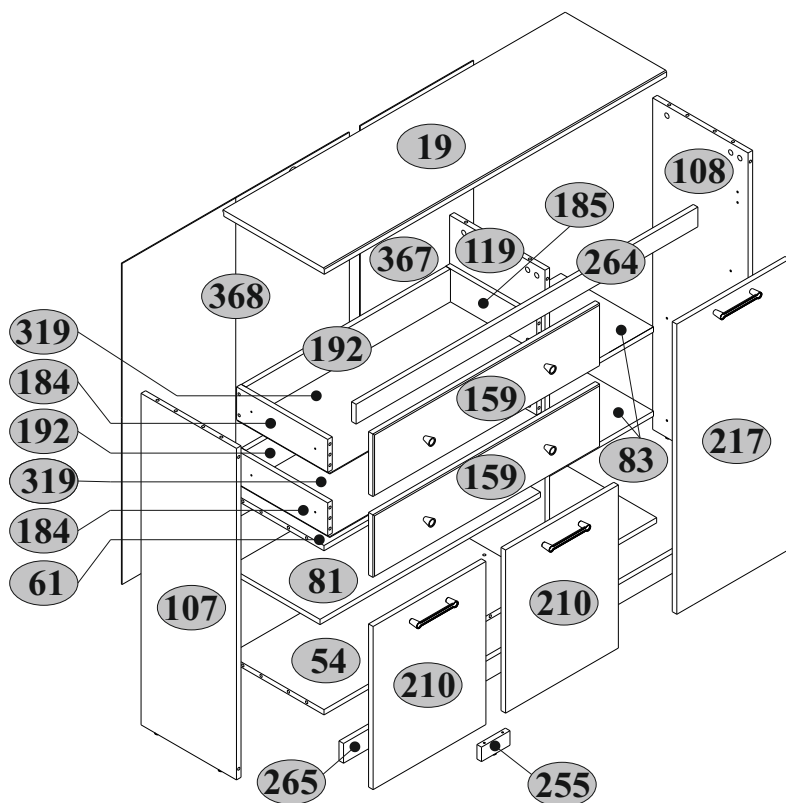



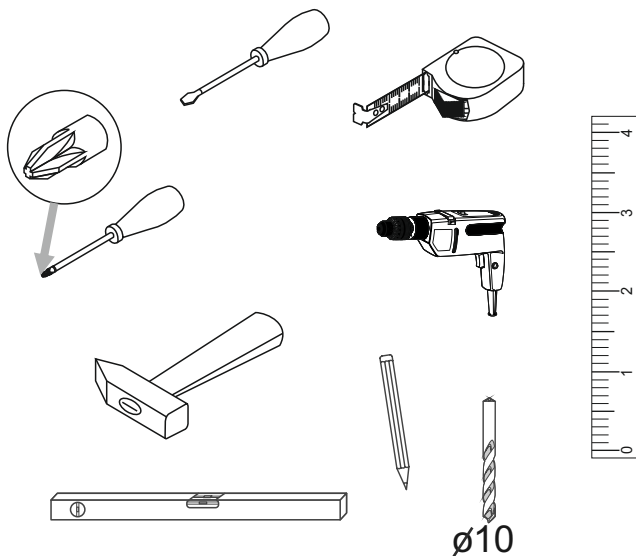
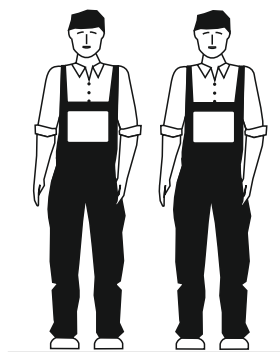



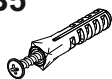
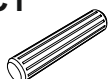
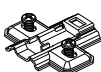
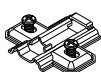
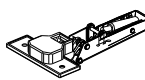
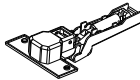





единая справочная служба:  
**8 800 100-50-22**  
(звонок по России бесплатный)

**LAZURIT** МЕБЕЛЬ



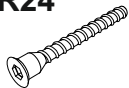

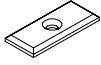

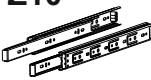

№ п/п	Наименование	Длина мм	Ширина мм	Толщина мм	Кол-во шт.	№ пачки
19	Крышка	1202	356	16	1	2/3
54	Полка соединительная нижняя	1168	335	16	1	1/3
61	Полка соединительная	776	335	16	1	1/3
81	Полка переставная большая	774	325	16	1	1/3
83	Полка переставная большая	374	325	16	2	1/3
107	Стенка боковая левая	1008	335	16	1	1/3
108	Стенка боковая правая	1008	335	16	1	1/3
119	Перегородка	948	335	16	1	2/3
159	Панель передняя ящика	796	190	16	2	3/3
184	Стенка боковая ящика левая	320	100	16	2	2/3
185	Стенка боковая ящика правая	320	100	16	2	2/3
192	Стенка задняя ящика	718	100	16	2	2/3
210	Дверь	496	396	16	2	3/3
217	Дверь большая	882	396	16	1	3/3
255	Опора центральная	100	44	16	1	2/3
264	Планка горизонтальная	1200	60	16	1	2/3
265	Царга	1200	60	16	1	2/3
319	Дно ящика	748	325	2,5	2	3/3
367	Стенка задняя правая	976	399	2,5	1	3/3
368	Стенка задняя	976	798	2,5	1	3/3
	Комплект фурнитуры				1	1/3

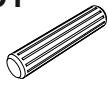
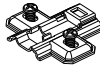



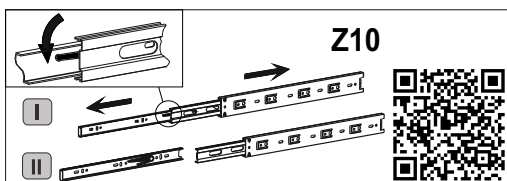
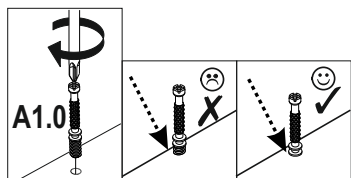
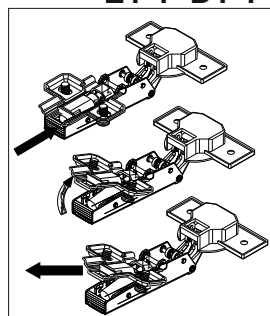
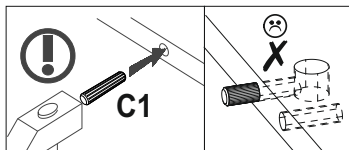
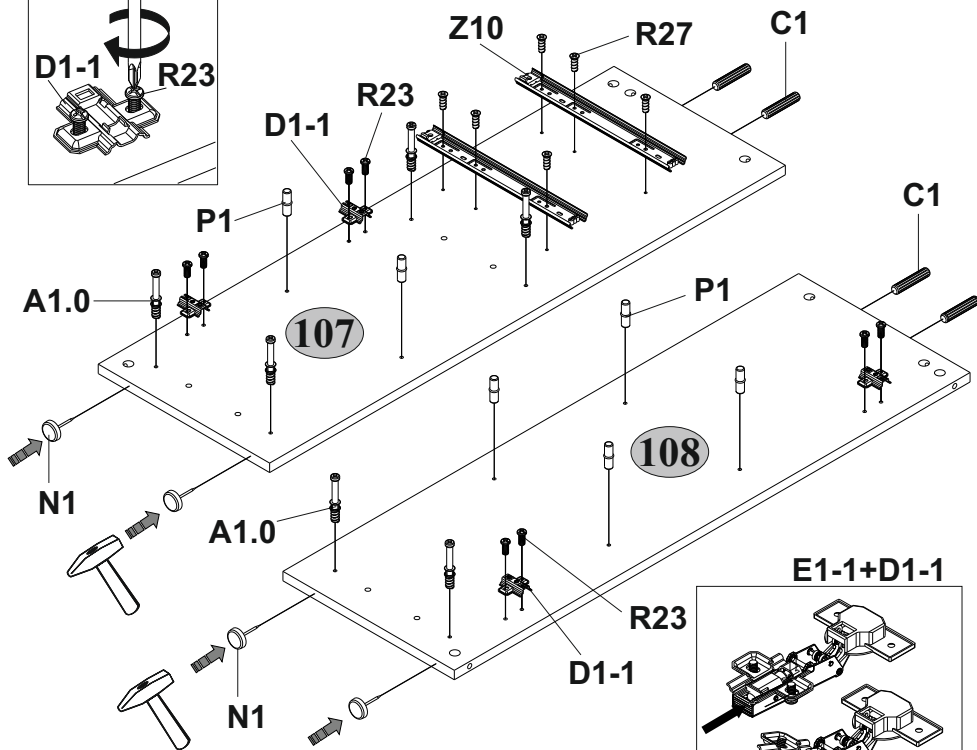
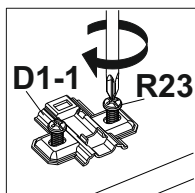

<b>A1.0</b>  5x28      30	<b>A2</b>  Ø15x13      30	<b>B5</b>  10x50      1	<b>C1</b>  8x35      26	<b>D1-1</b>  4	<b>D1-3</b>  2
<b>E1-1</b>  4	<b>E4-1</b>  2	<b>G</b>  1,5x26      40	<b>H27</b>  3	<b>H30</b>  4	<b>I</b>  S4      1
<b>L1</b>  320      2	<b>M4</b>  M4x22      10	<b>N1</b>  5	<b>P1</b>  Ø5      12	<b>Q</b>  1,5x7      4	<b>R3</b>  3x20      30
<b>R23</b>  6,3x13      12	<b>R24</b>  7x50      10	<b>R27</b>  5,0x13      20	<b>R102</b>  3,5x16      18	<b>S3</b>  6	<b>S5</b>  Ø18      15
<b>U</b>  90x35x15      1	<b>Z10</b>  300      2				

3

<b>A1.0</b>  5x28      6	<b>C1</b>  8x35      4	<b>D1-1</b>  4	<b>N1</b>  4	<b>P1</b>  Ø5      6
<b>R23</b>  6,3x13      8	<b>R27</b>  5,0x13      6	<b>Z10</b>  300      1		

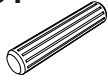
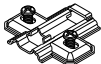

4

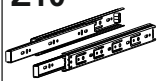
<b>A1.0</b>  5x28 2	<b>C1</b>  8x35 4	<b>D1-3</b>  2	<b>P1</b>  Ø5 2	<b>R23</b>  6,3x13 4
<b>R27</b>  5,0x13 6	<b>Z10</b>  300 1			

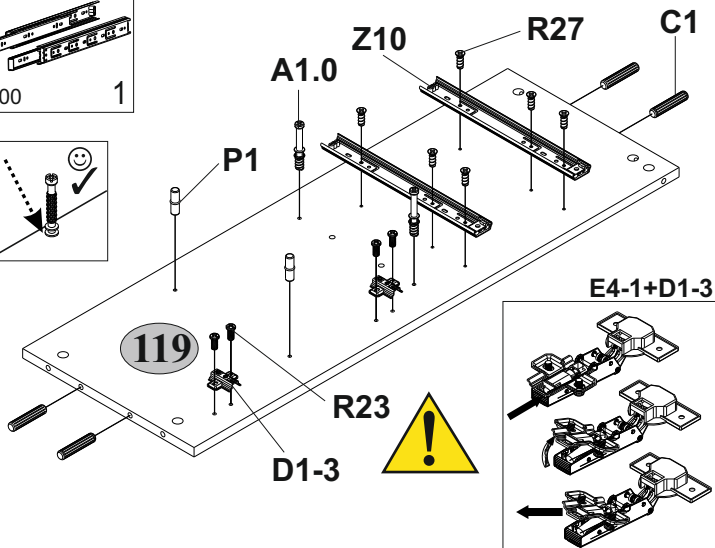
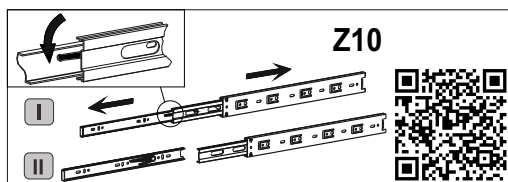
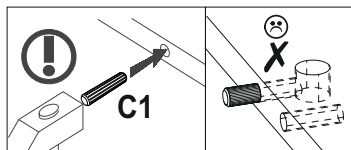
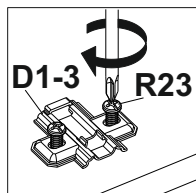
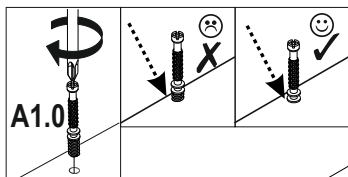

5

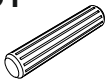
<b>C1</b>  8x35 4
--

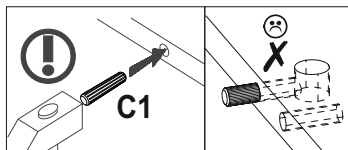
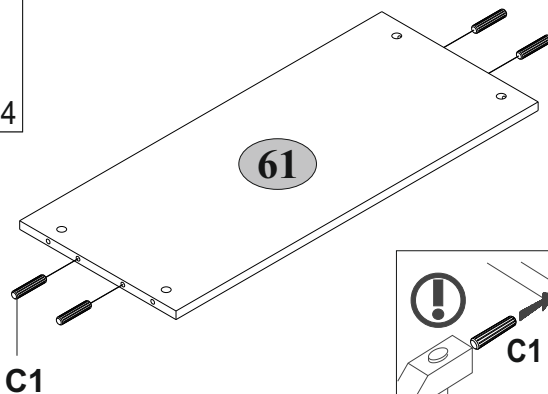

6

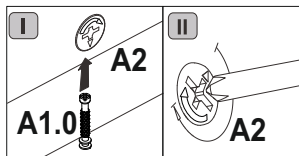
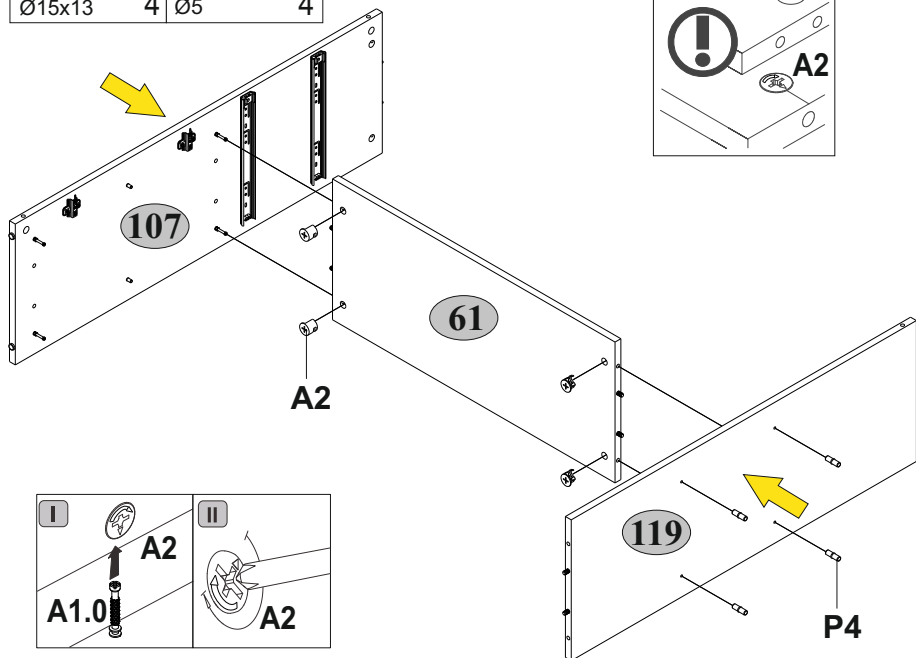
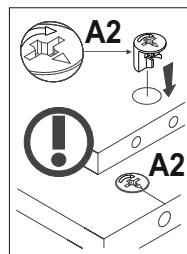
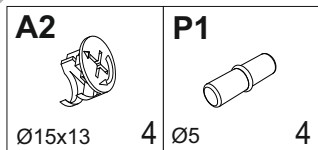

7

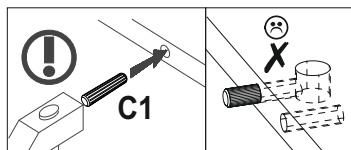
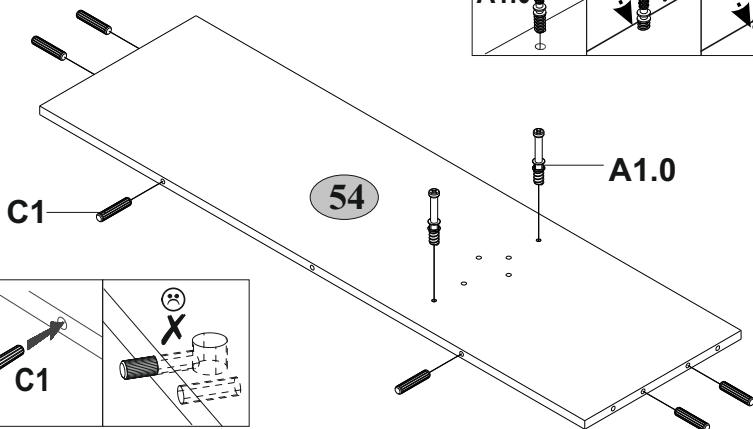
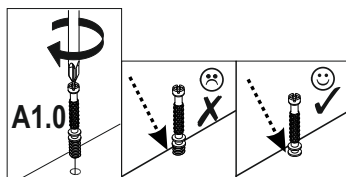
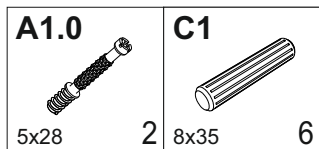

8

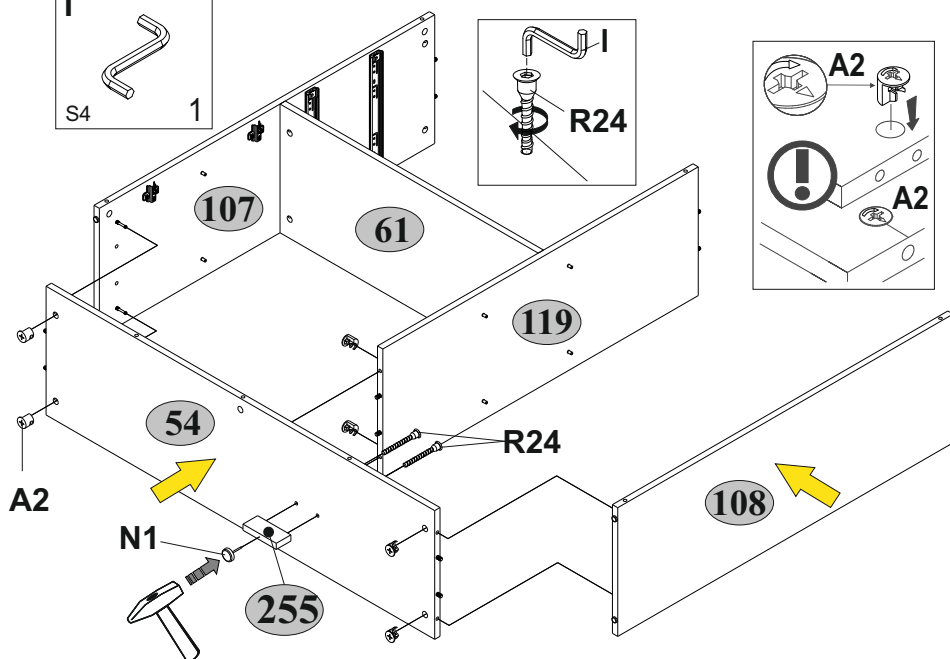
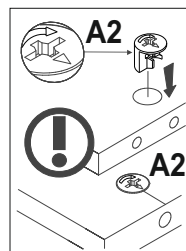
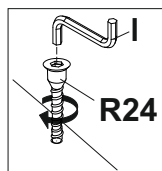
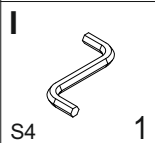
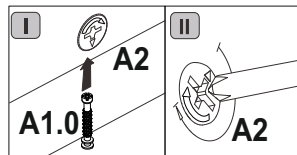
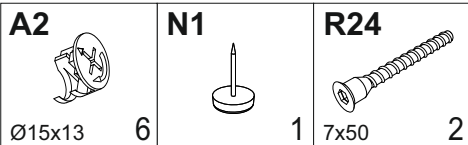

9

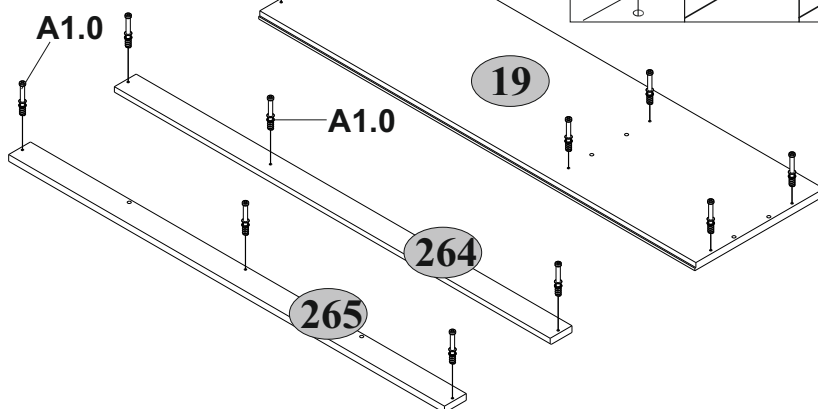
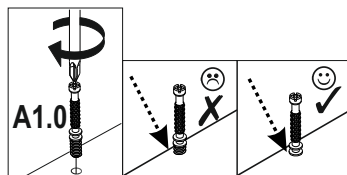
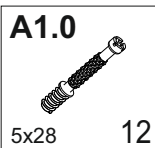

10

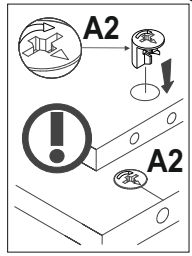
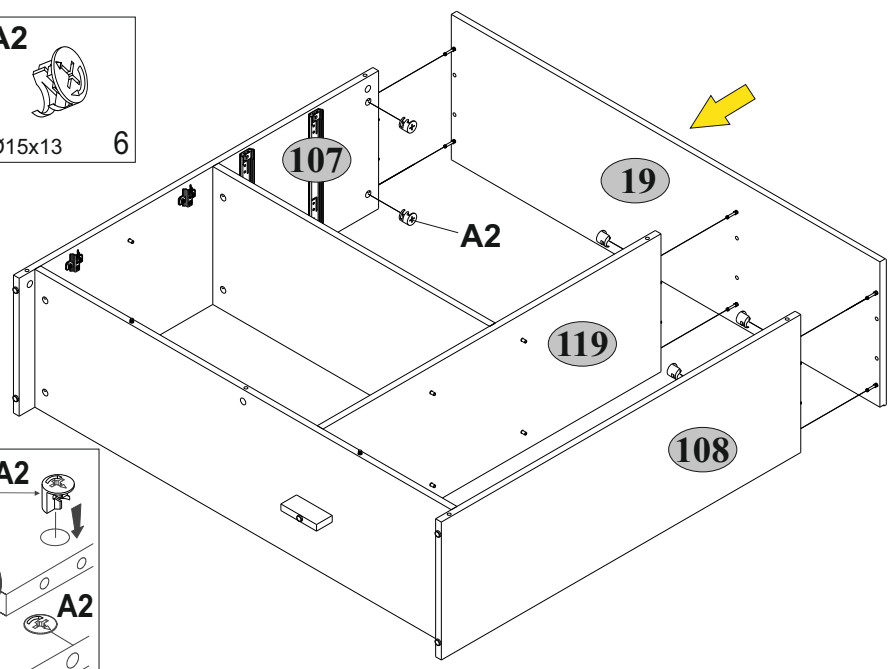
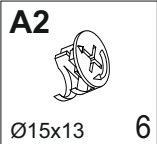

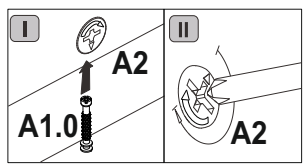
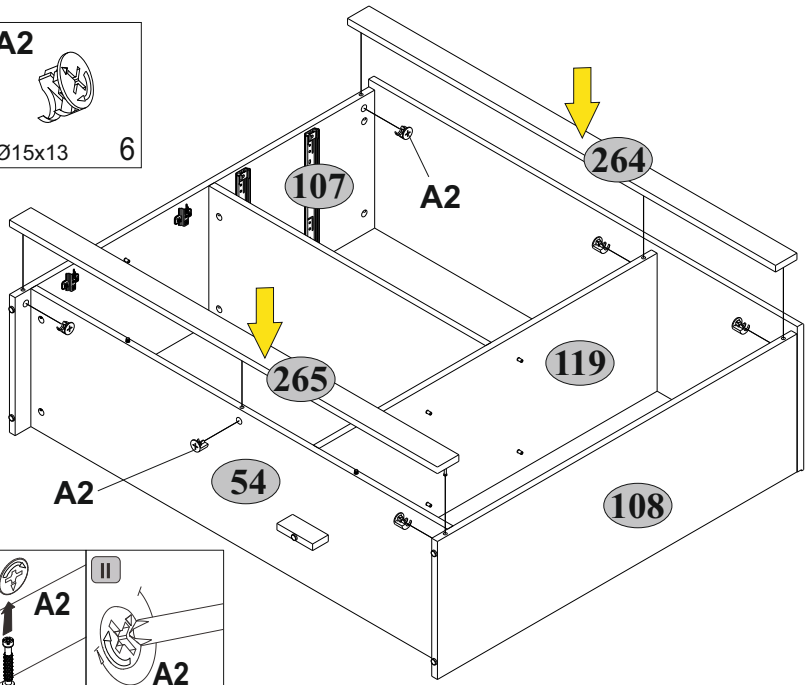
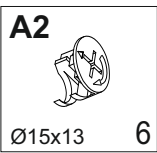

11





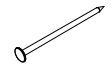

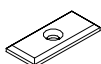
12

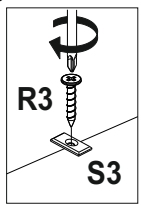
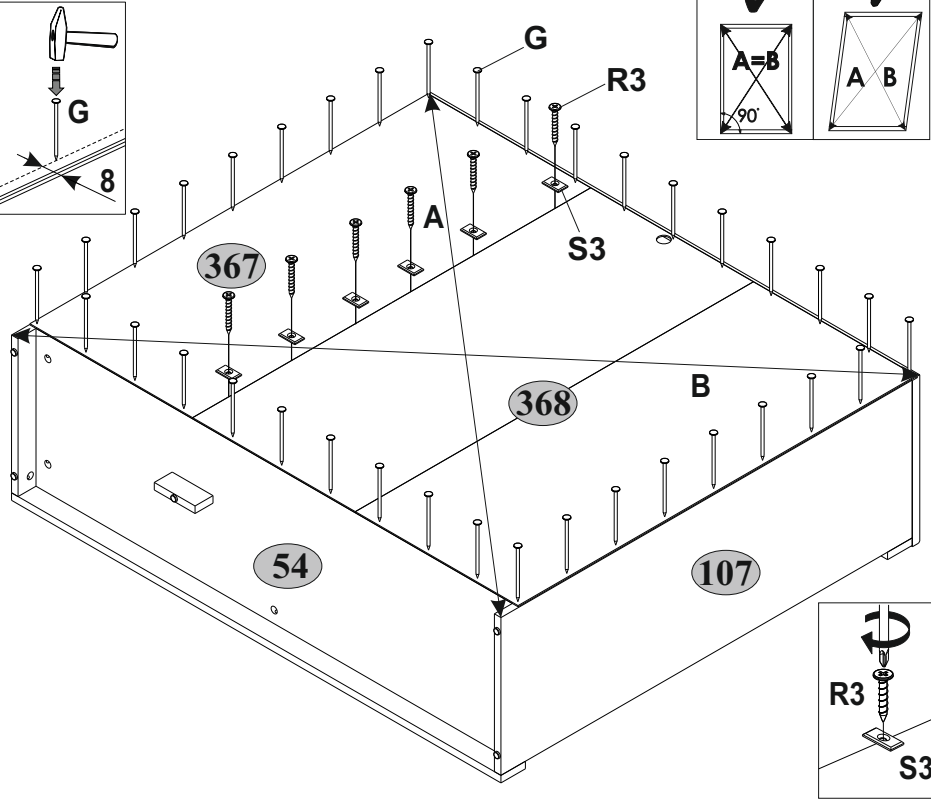
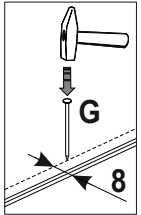
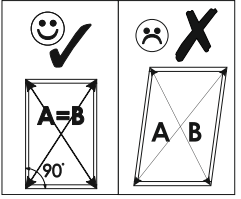
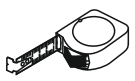
<b>G</b>  1,5x26    40	<b>R3</b>  3x20    6	<b>S3</b>  6    6
---	---	--



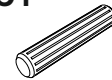

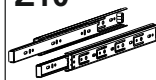

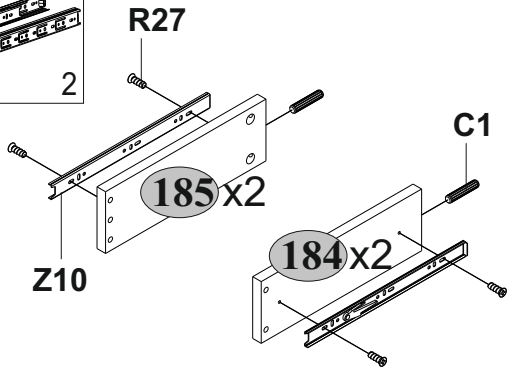
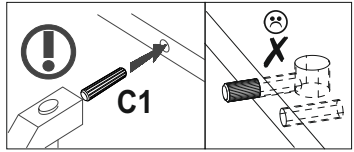

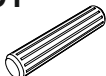

13

<b>C1</b>  8x35    4	<b>R27</b>  5,0x13    8	<b>Z10</b>  300    2
---	--	---



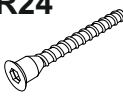

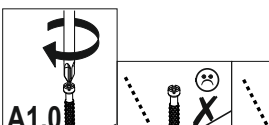
# 14 x2

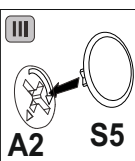
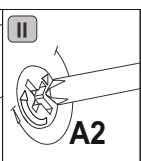
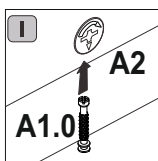
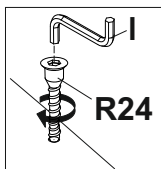
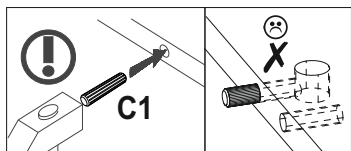
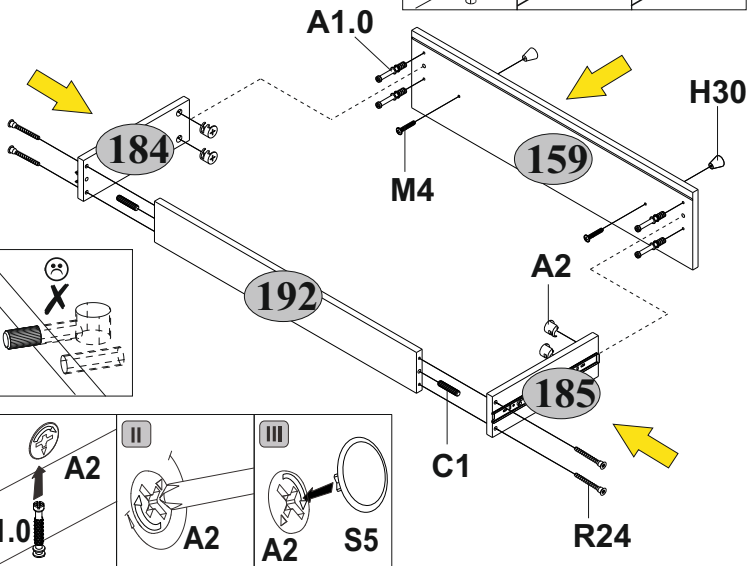
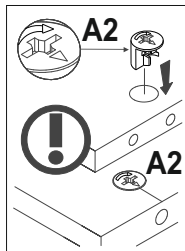



<b>A1.0</b>  5x28 8	<b>A2</b>  Ø15x13 8	<b>C1</b>  8x35 4	<b>H30</b>  4	<b>I</b>  S4 1
<b>M4</b>  M4x22 4	<b>R24</b>  7x50 8	<b>S5</b>  Ø18 8		



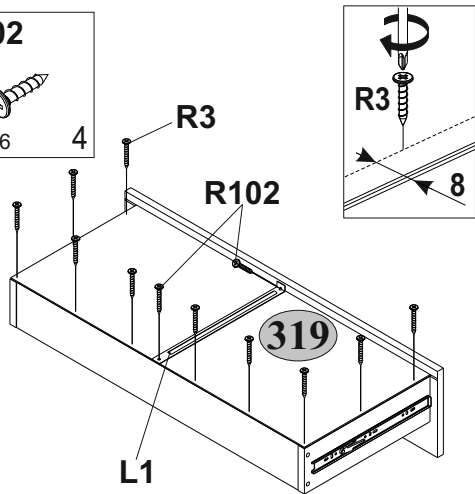
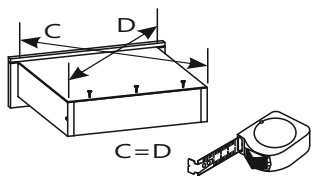

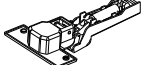

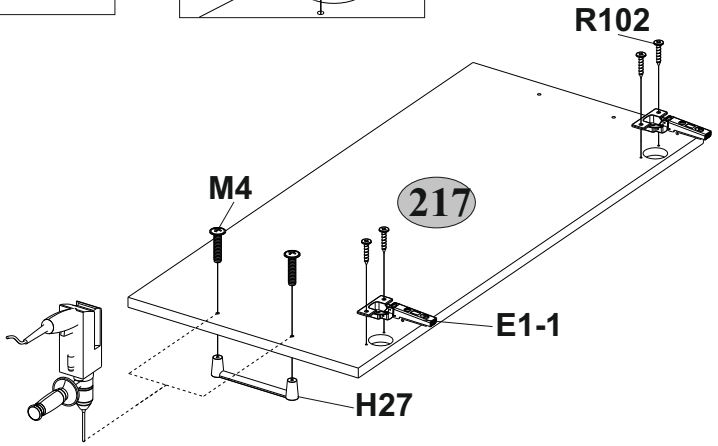
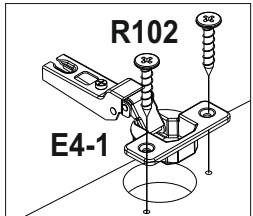
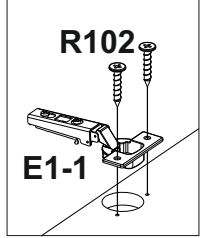
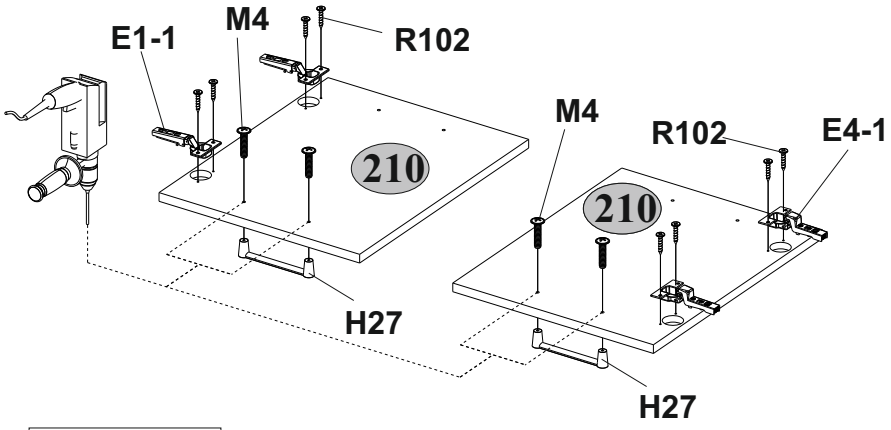

# 15 x2

<b>L1</b>  320 2	<b>R3</b>  3x20 20	<b>R102</b>  3,5x16 4
--	--	---





<p><b>E1-1</b></p>  <p>4</p>	<p><b>E4-1</b></p>  <p>2</p>	<p><b>H27</b></p>  <p>3</p>	<p><b>M4</b></p>  <p>6 M4x22</p>	<p><b>R102</b></p>  <p>6 3,5x16 12</p>
---	---	--	---	---

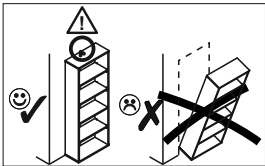
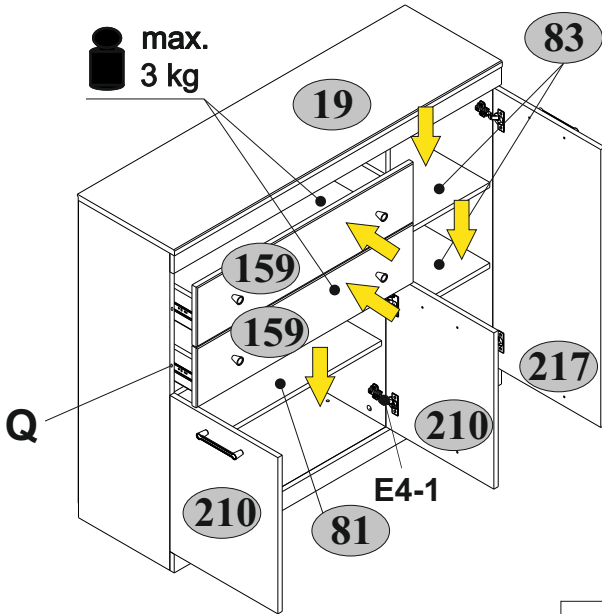
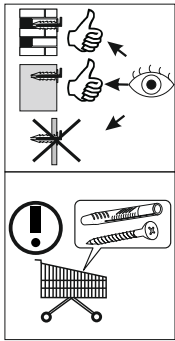
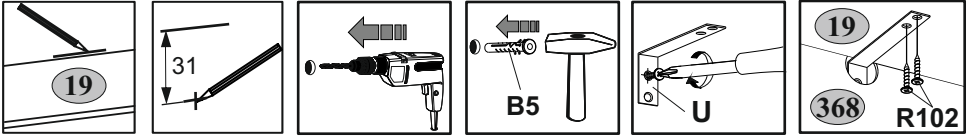

<b>B5</b>  10x50 1	<b>Q</b>  1,5x7 4	<b>R102</b>  3,5x16 2	<b>S5</b>  Ø18 7	<b>U</b>  90x35x15 1
---	--	--	---	---



19  max. 15 kg  
81 83  max. 5 kg

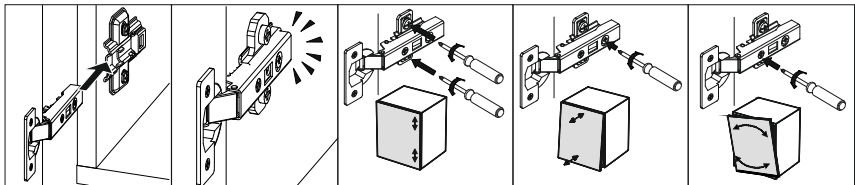
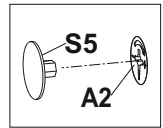



## Инструкция по уходу за мебелью и правила эксплуатации

1. Мебель рекомендуется эксплуатировать в бытовых помещениях с температурой воздуха не ниже +2°C и относительной влажностью 45-70 %.
2. Мебель должна быть защищена от воздействия прямых солнечных лучей, так как это вредит внешнему виду изделий и может изменить цвет поверхности.
3. Не следует ставить на поверхность мебели горячие предметы.
4. Случайно попавшую на поверхность изделия влагу, жидкость следует снять сухой тканью.
5. Удаление пыли с полированной или лакированной поверхности следует производить сухой тканью (фланель, миткаль).
6. Полированные и лакированные поверхности мебели рекомендуется освежать специально предназначенными для этого средствами.
7. Очищать стекла рекомендуется специальными составами, нанесенными на мягкую ткань.
8. Не допускается применение соды, стиральных порошков, абразивных паст, порошков и прочих, не предназначенных для ухода за изделиями мебели препаратов.

### Гарантии изготовителя

1. Гарантийный срок эксплуатации изделия - 36 месяцев со дня продажи магазином. В период гарантийного срока изготовитель гарантирует ремонт изделий или их замену, если потребителем не нарушены правила эксплуатации.
2. Претензии предъявляются потребителем непосредственно в торгующую организацию, в которой была приобретена мебель, предъявив настоящую "Инструкцию по сборке" и копию товарного чека.
3. Изделие, соответствует требованиям ГОСТ 16371-2014, ТР ТС 025/2012, ЕАЭС № ВУ/112 11.01. ТР025 018.01 00279 от 22.06.2021 по 21.06.2026.
4. Срок службы мебели - 5 лет.
5. Предприятие-изготовитель оставляет за собой право вносить изменения в конструкцию изделия, не ухудшая его конструктивные и эксплуатационные характеристики.
6. Для сборки изделий рекомендуется привлекать квалифицированных специалистов.

### Запах.

От новой мебели может исходить запах материалов, из которых она изготовлена. Запах может сохраняться в течение трёх недель с момента сборки. Для снижения интенсивности запаха рекомендуется:

-для мягкой мебели - пропылесосить изделие и проветрить помещение.

Повторять 3-4 раза в день.

-для корпусной мебели – протирать тканью, смоченной мягким моющим средством, вытирать чистой сухой тканью и проветривать помещение, предварительно открывая все двери и ящики изделия.

Повторять 3-4 раза в день.

**Важно!** Сохраните, пожалуйста, инструкцию в случае повторной сборки мебели или рекламации. В случае составления рекламации пользуйтесь, пожалуйста, обозначением из инструкции сборки.