

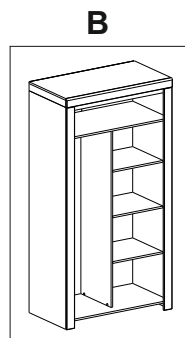

инструкция по сборке
Набор мебели для общей комнаты
«Виттория»

4960 л белый глянец вотан
Шкаф

4961 л белый глянец вотан
Шкаф

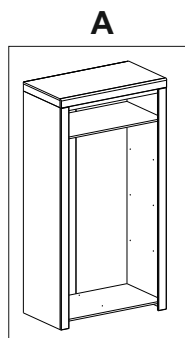
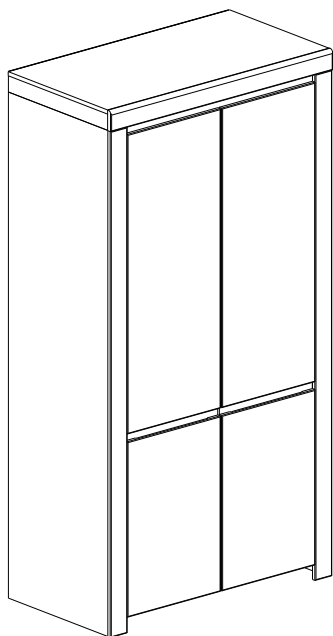

габаритные размеры:

высота — 2034 мм
ширина — 1060 мм
глубина — 582 мм

Дата выпуска

единая справочная служба:
8 800 100-50-22
(звонок по России бесплатный)

LAZURIT МЕБЕЛЬ

1

4960 л белый глянец вотан
Шкаф

А

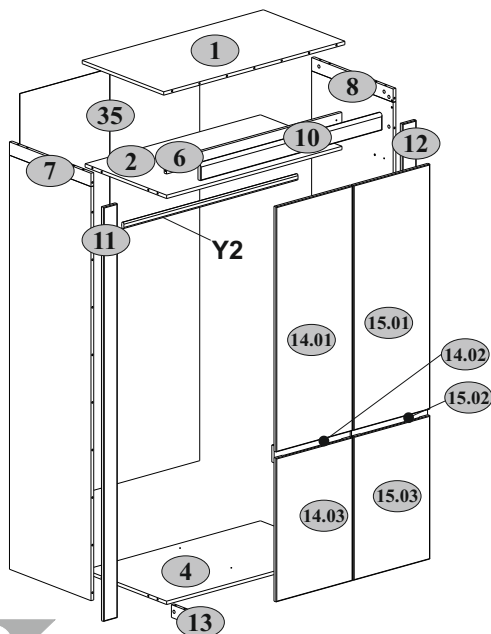

*4961 л белый глянец вотан
Шкаф

В

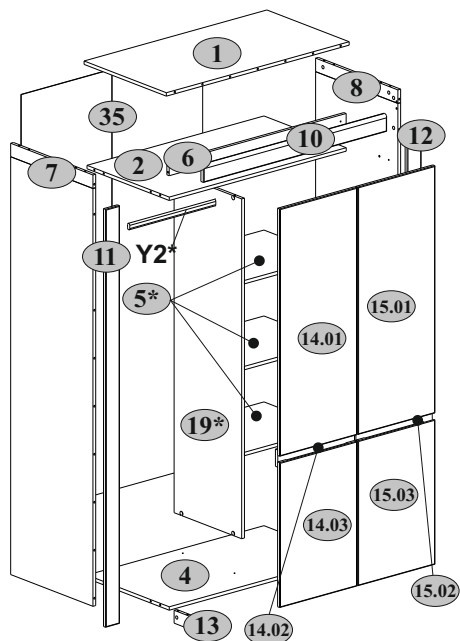







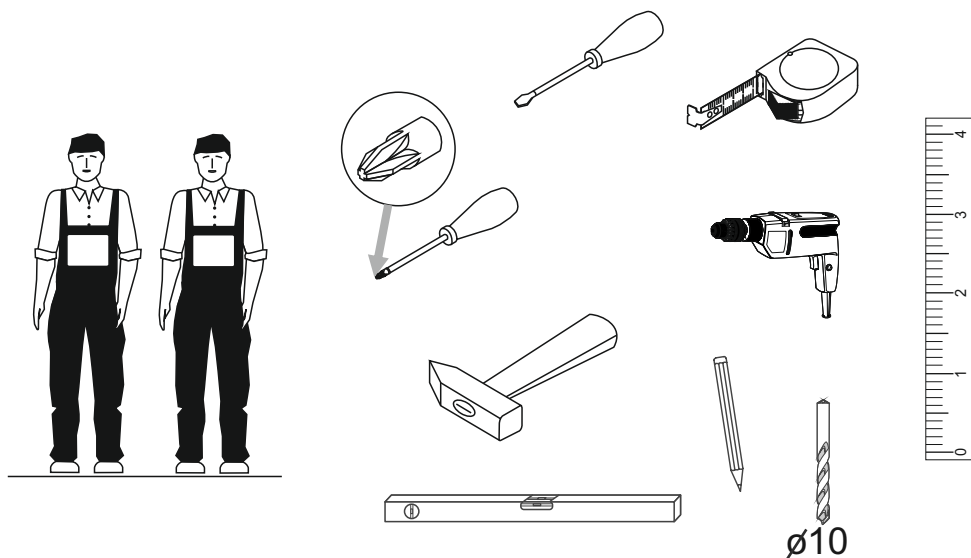







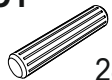
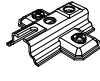
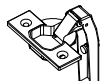
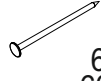

2

№ п/п	Наименование	Длина мм	Ширина мм	Толщина мм	Кол-во шт.	№ пачки
1	Щит верхний	1058	560	16	1	1/3;1/4*
2	Полка соединительная верхняя	1024	560	16	1	1/3;1/4*
4	Полка соединительная нижняя	1024	560	16	1	1/3;1/4*
5*	Полка соединительная	504	540	16	3	4/4*
6	Планка горизонтальная	1024	60	16	1	1/3;1/4*
7	Стенка боковая левая	2013	560	16	1	2/3;2/4*
8	Стенка боковая правая	2013	560	16	1	2/3;2/4*
10	Планка горизонтальная декор.	1060	80	19	1	1/3;1/4*
11	Планка вертикальная декор. лев.	1950	80	16	1	2/3;2/4*
12	Планка вертикальная декор. пр.	1950	80	16	1	2/3;2/4*
13	Опора центральная	200	60	16	1	1/3;1/4*
14.01	Щит двери верхний левый	446	1154	16	1	3/3;3/4*
14,15.02	Планка двери	444	80	16	2	1/3;1/4*
14.03	Щит двери нижний левый	446	676	16	1	3/3;3/4*
15.01	Щит двери верхний правый	446	1154	16	1	3/3;3/4*
15.03	Щит двери нижний правый	446	676	16	1	3/3;3/4*
19*	Перегородка	1636	540	16	1	4/4*
35	Стенка задняя	1965	1050	2,5	1	2/3;2/4*
Y2	Штанга	1017			1	1/3
Y2*	Штанга	498			1	1/4*

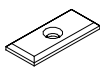
3

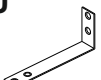

4

A1.0  5x28 30 30*	A2  $\varnothing 15 \times 13$ 30 30*	A7  0 16*	A8  20x13 0 16*	B5  10x50 1 1*	C1  8x35 28 28*
D1  8 8*	E2  8 8*	G  1,5x26 60 60*	N1  5 5*	Q  1,5x7 4 4*	R3  3x20 6 6*
R10  4x30 15 15*	R23  6,3x13 16 16*	R102  3,5x16 22 22*	S3  6 6*	S5  $\varnothing 18$ 12 12*	S5  $\varnothing 18$ 10 10*
S11  $\varnothing 8$ 10 0*	U  90x35x15 1 1*	Y1  2 2*			

5

A

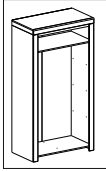

A1.0



5x28

8

C1

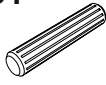

8x35

4

N1



4

R102



3,5x16

4

S11



Ø8

6

Y1



2

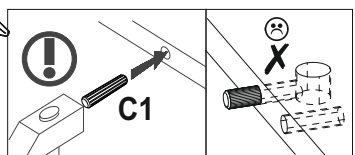
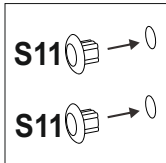
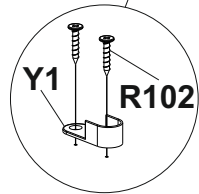
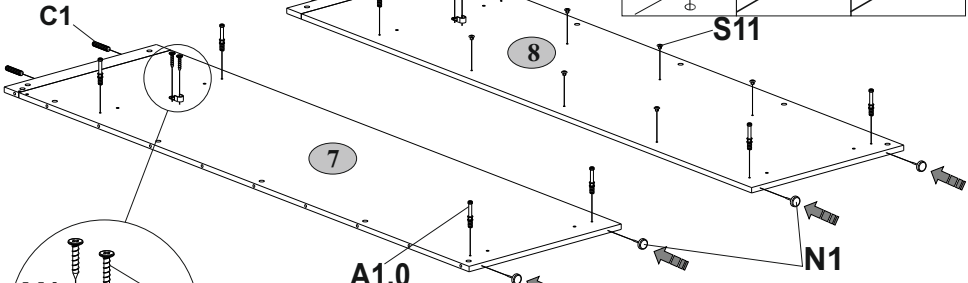
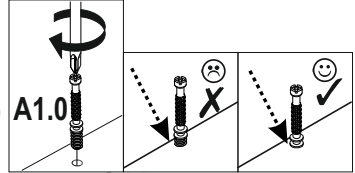

5

B

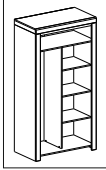

A1.0



5x28

8*

A7



6*

C1

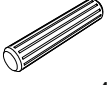

8x35

4*

N1



4*

R102



3,5x16

2*

Y1



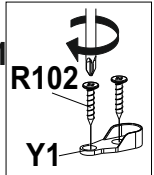
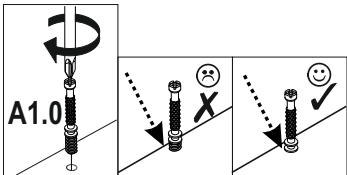
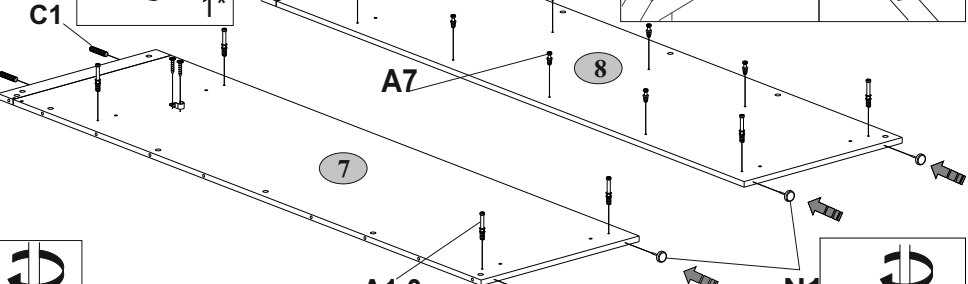
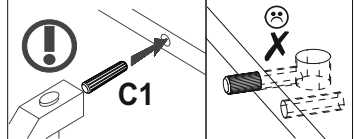

1*

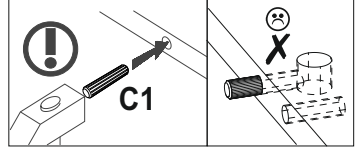
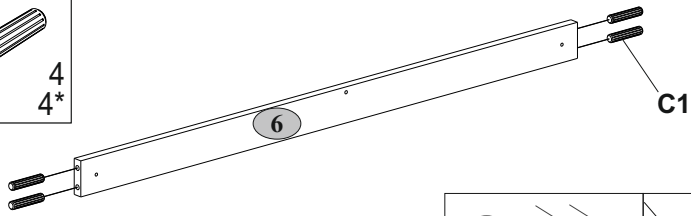
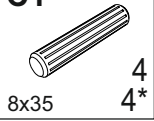
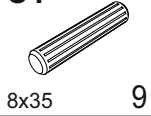
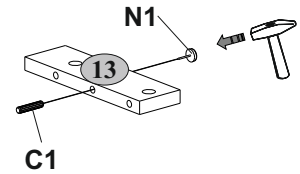
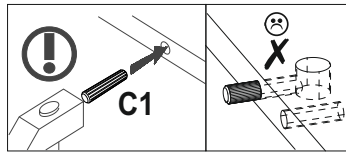
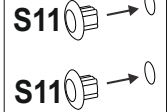
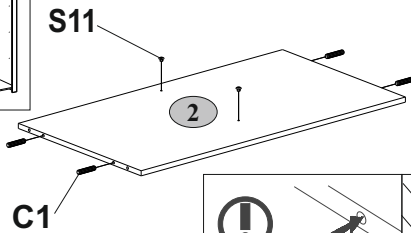
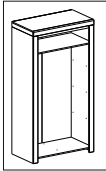
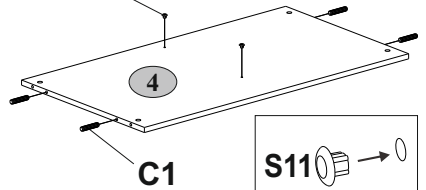
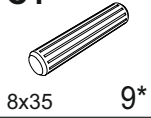
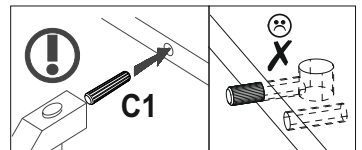
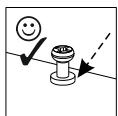
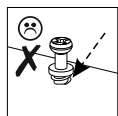
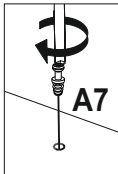
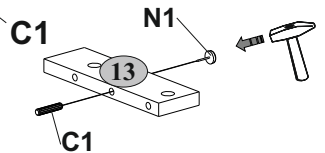
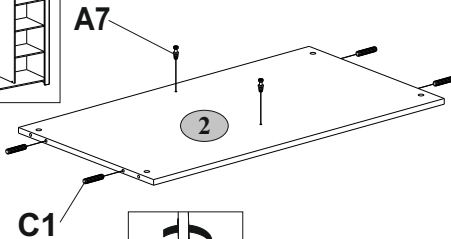
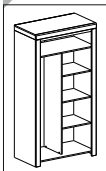
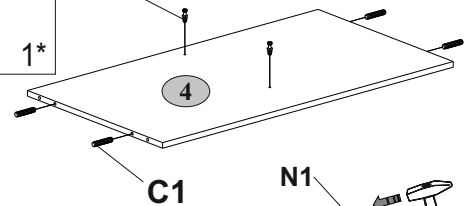

6**C1****7****A****C1****N1****S11****S11****7****B****C1****A7****N1****A7**

8

A1.0	A2
	
2	10
5x28	2* Ø15x13 10*

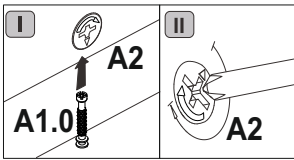
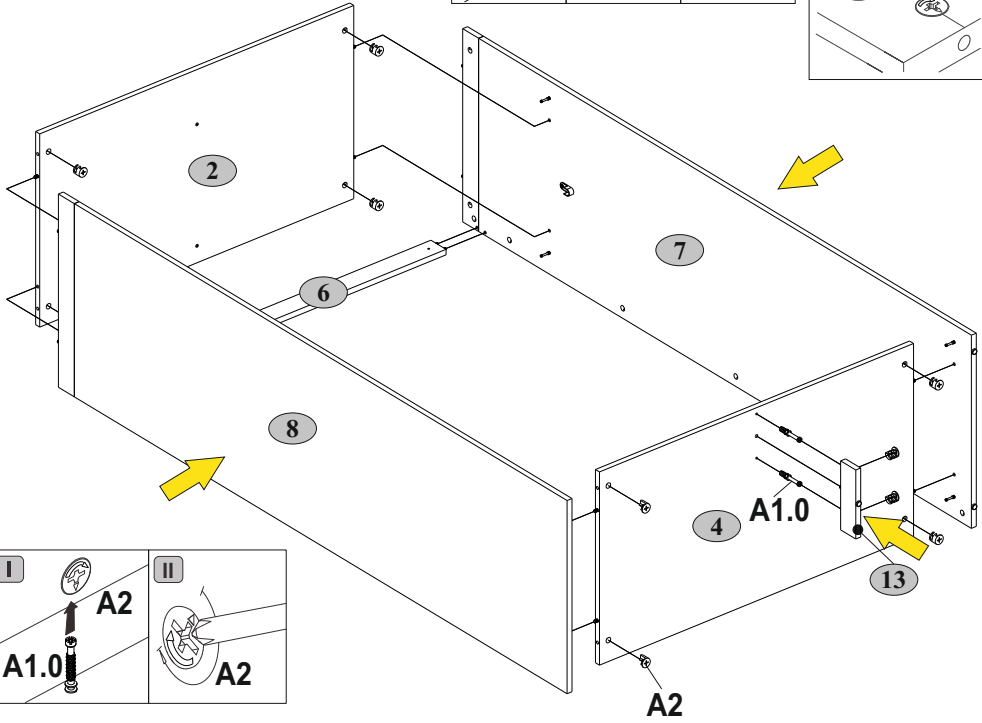
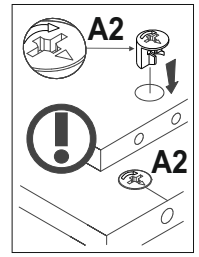
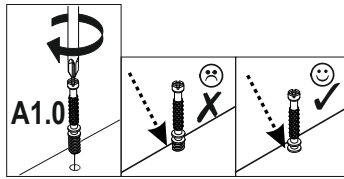

9

A1.0	
	
4	
5x28	4*

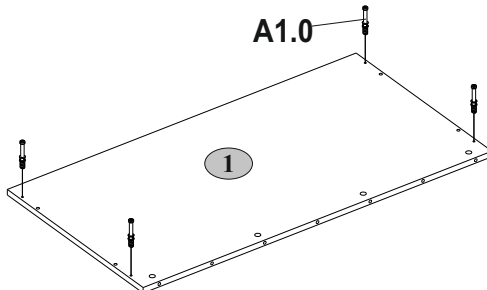
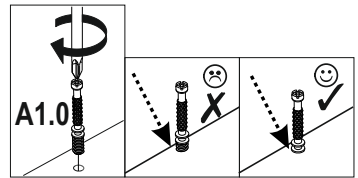

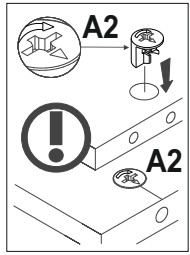

10

A2

 4
 Ø15x13
 4*

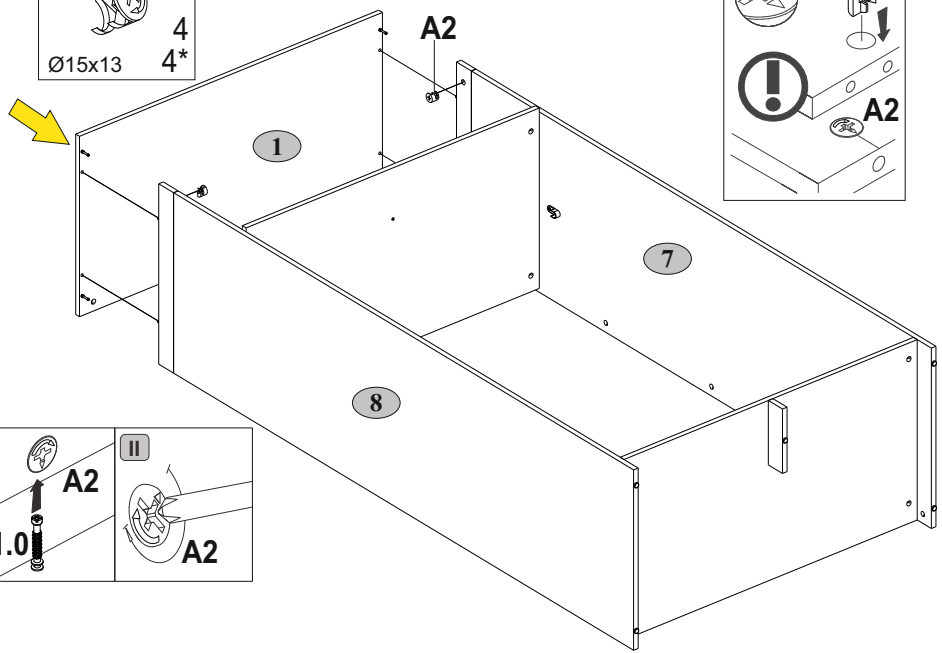

A2
A2



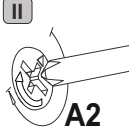

I

A2
A1.0

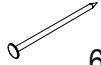
II

A2

11

G

 60
 1,5x26
 60*

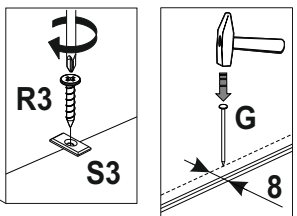
R3

 6
 3x20
 6*

S3

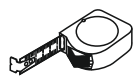
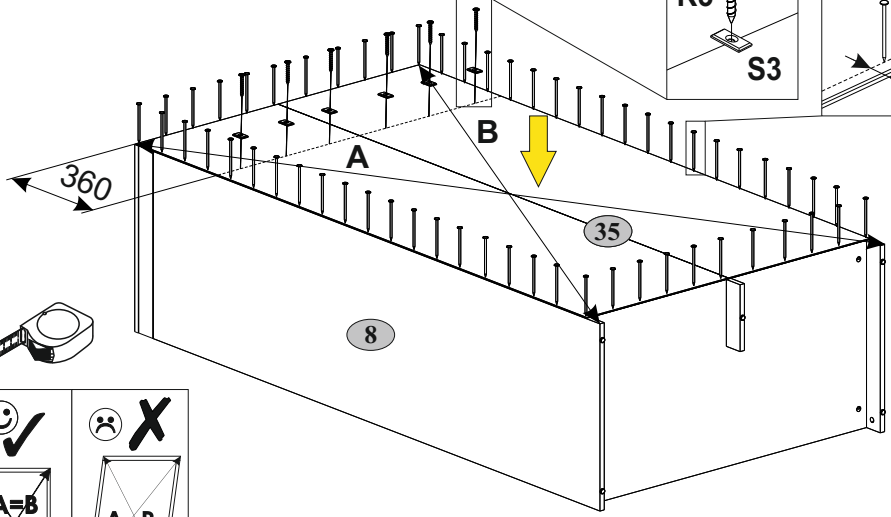
 6
 6*



R3
S3
G
 8





 ✓

 ✗

A=B
 90°

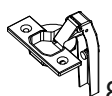

A B

12

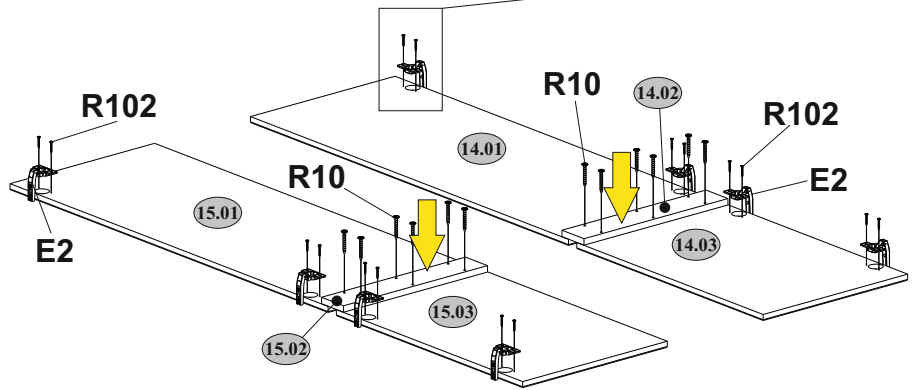
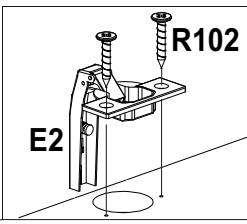
<p>E2</p>  <p>8 8*</p>	<p>R10</p>  <p>4x30 12 12*</p>	<p>R102</p>  <p>3,5x16 16 16*</p>
---	---	---

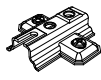

13



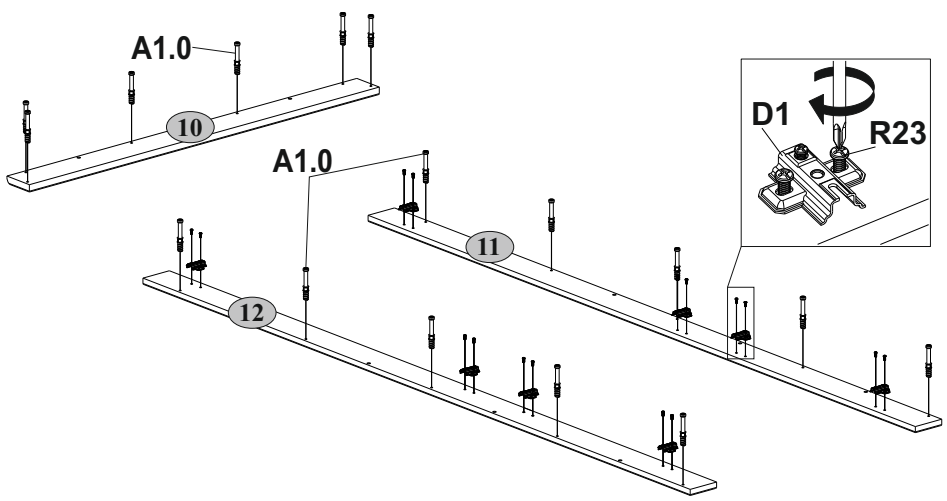
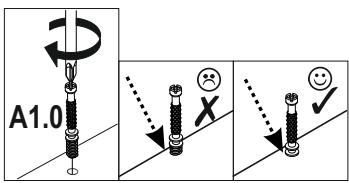

<p>A1.0</p>  <p>5x28 16 16*</p>	<p>D1</p>  <p>8 8*</p>	<p>R23</p>  <p>6,3x13 16 16*</p>
---	--	--

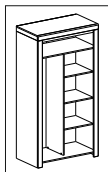

14

B



A7 	A8 	R102 	Y1 
6*	20x13	4*	3,5x16
		2*	1*

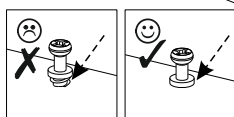
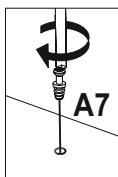
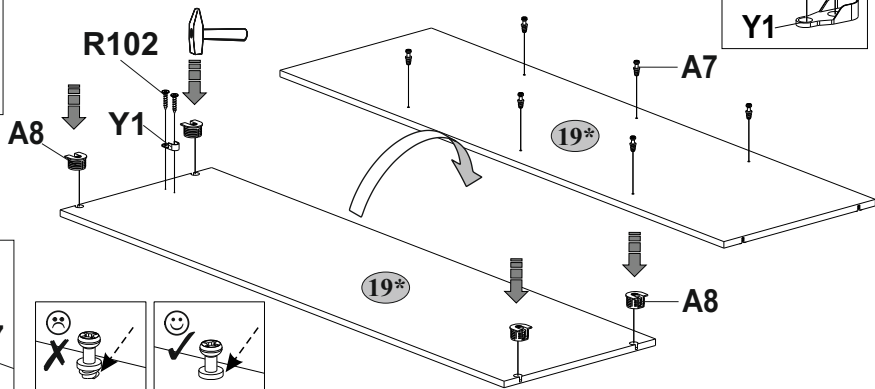
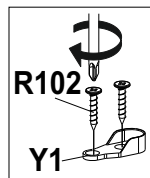

15

B

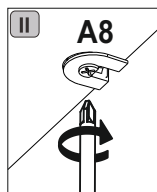
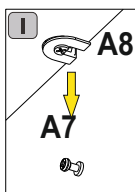
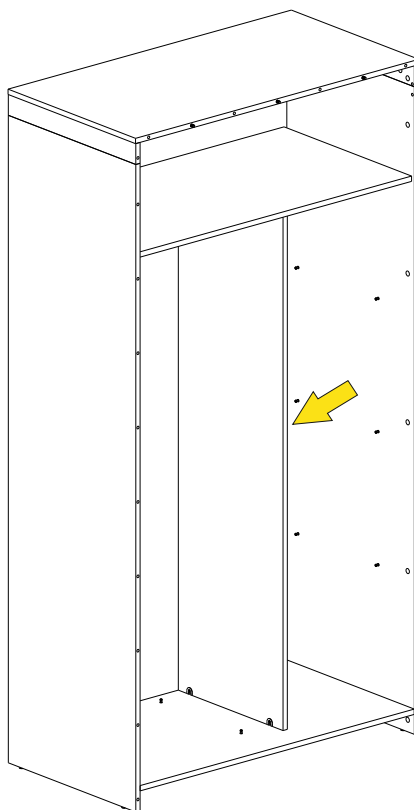
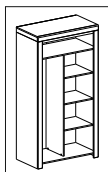

16

A

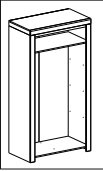

A2



Ø15x13

16

C1

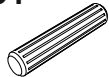

8x35

11

R10

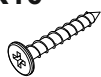

4x30

3

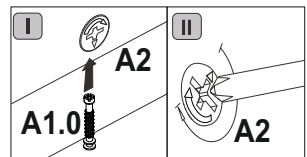
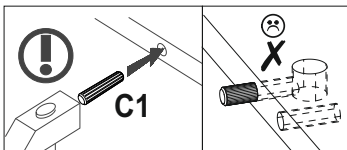
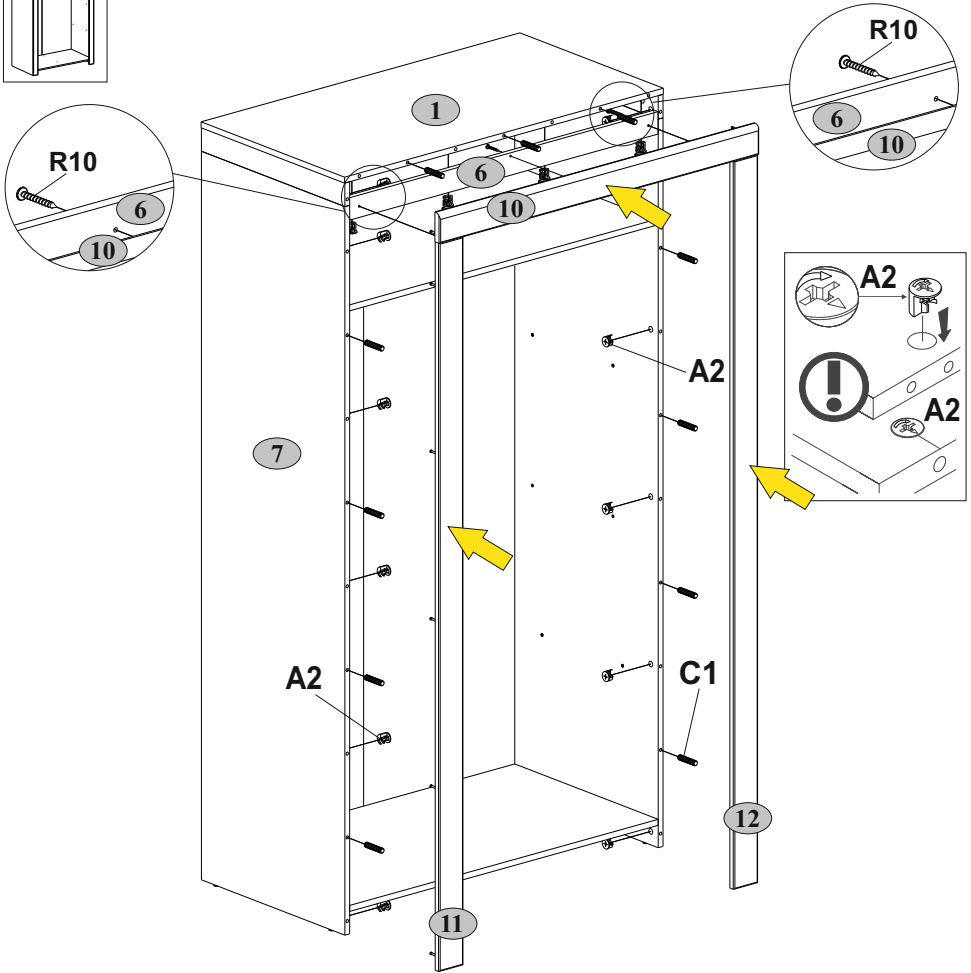

16

B

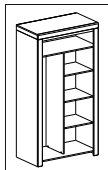

A2



∅15x13 16*

A8



20x13 12*

C1

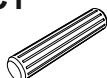

8x35 11*

R10



4x30 3*

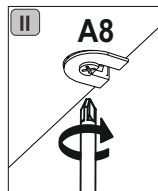
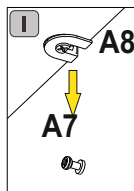
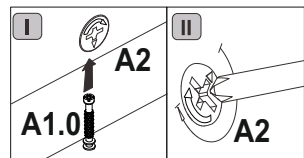
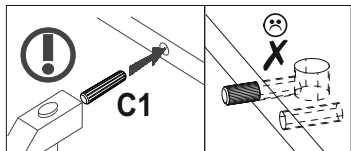
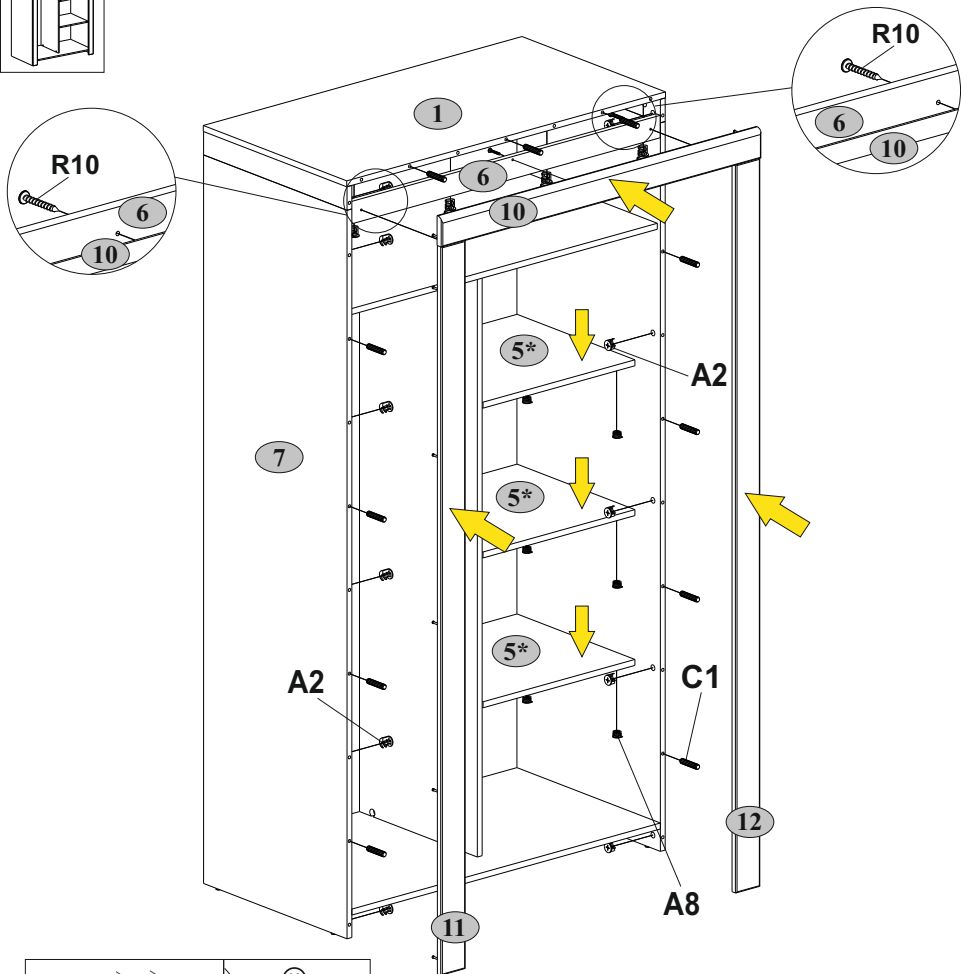

17

A

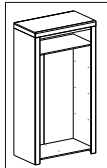

B5 10x50 1	Q 1,5x7 4	R102 3,5x16 2	S5 Ø18 12	S5 Ø18 10
U 90x35x15 1				

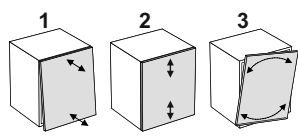
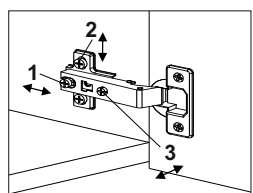
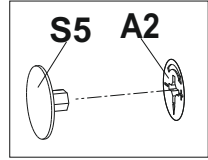
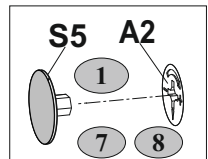
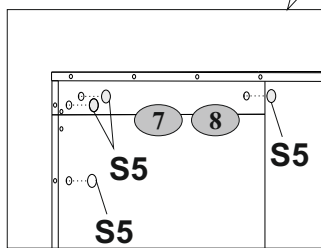
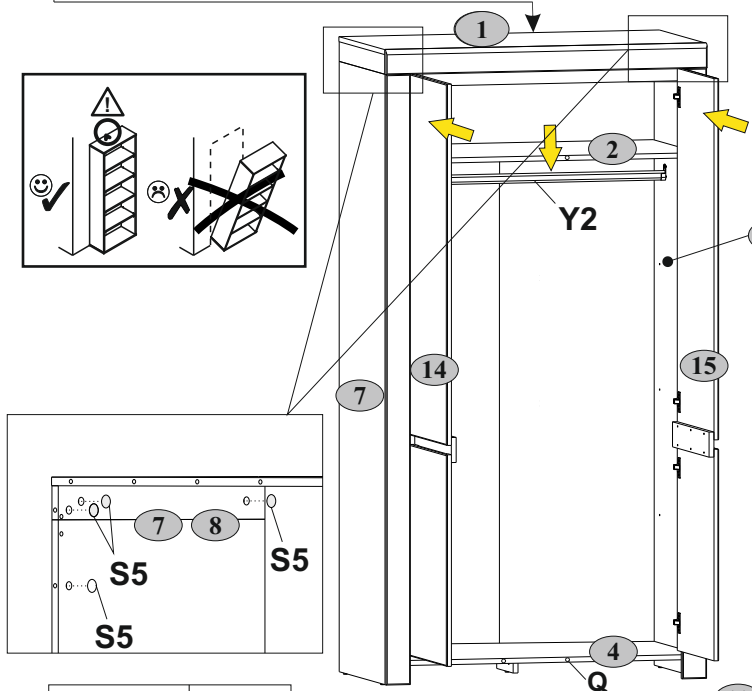
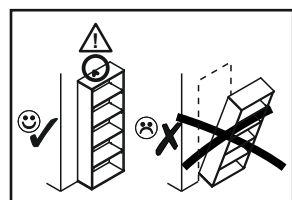
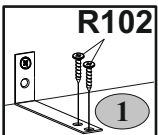
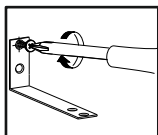
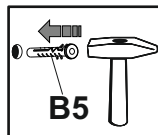
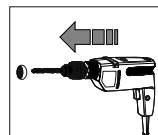
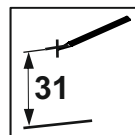
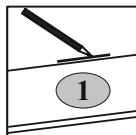



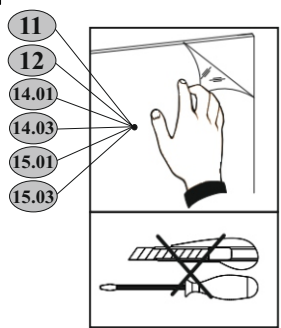



2 max. 5 kg
 Y2 4 max. 10 kg

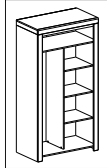

17

B

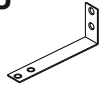

B5  10x50 1*	Q  1,5x7 4*	R102  3,5x16 2*	S5  Ø18 12*	S5  Ø18 10*
U  90x35x15 1*				

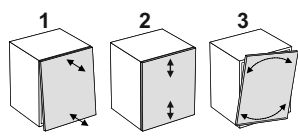
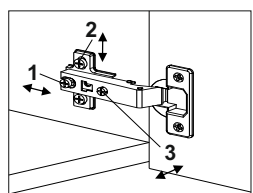
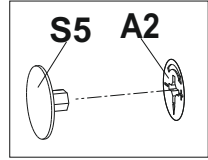
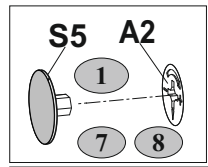
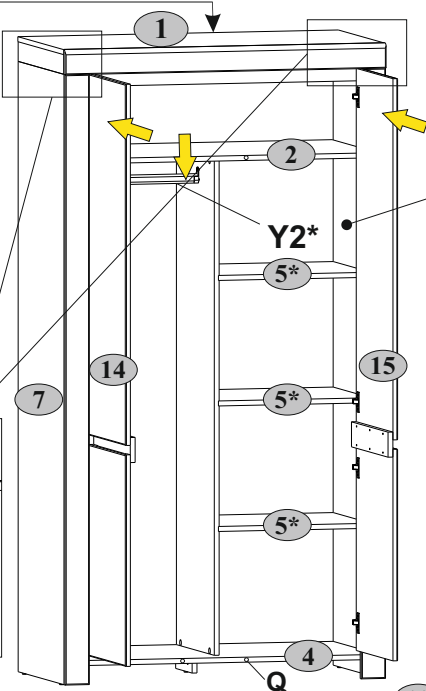
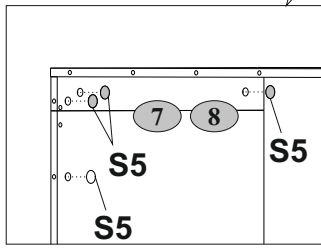
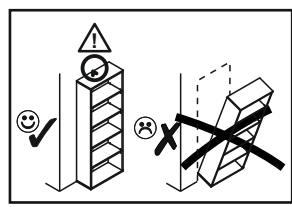
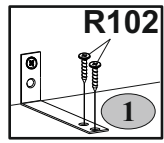
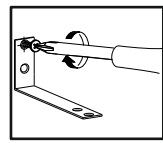
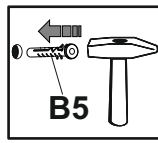
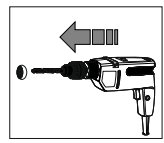
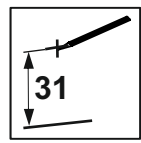
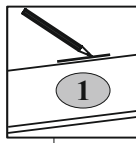

2 5*  max. 5 kg

Y2* 4  max. 10 kg

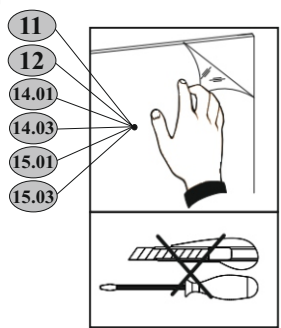



Инструкция по уходу за мебелью и правила эксплуатации

1. Мебель рекомендуется эксплуатировать в бытовых помещениях с температурой воздуха не ниже +2°C и относительной влажностью 45-70 %.
2. Мебель должна быть защищена от воздействия прямых солнечных лучей, так как это вредит внешнему виду изделий и может изменить цвет поверхности.
3. Не следует ставить на поверхность мебели горячие предметы.
4. Случайно попавшую на поверхность изделия влагу, жидкость следует снять сухой тканью.
5. Удаление пыли с полированной или лакированной поверхности следует производить сухой тканью (фланель, миткаль).
6. Полированные и лакированные поверхности мебели рекомендуется освежать специально предназначенными для этого средствами.
7. Очищать стекла рекомендуется специальными составами, нанесенными на мягкую ткань.
8. Не допускается применение соды, стиральных порошков, абразивных паст, порошков и прочих, не предназначенных для ухода за изделиями мебели препаратов.

Гарантии изготовителя

1. Гарантийный срок эксплуатации изделия - 36 месяцев со дня продажи магазином. В период гарантийного срока изготовитель гарантирует ремонт изделий или их замену, если потребителем не нарушены правила эксплуатации.
2. Претензии предъявляются потребителем непосредственно в торгующую организацию, в которой была приобретена мебель, предъявив настоящую "Инструкцию по сборке" и копию товарного чека.
3. Изделие, соответствует требованиям ГОСТ 16371-2014, ТР ТС 025/2012, ЕАЭС № ВУ/112 11.01. ТР025 018.01 00278 от 22.06.2021 по 20.06.2026.
4. Срок службы мебели - 5 лет.
5. Предприятие-изготовитель оставляет за собой право вносить изменения в конструкцию изделия, не ухудшая его конструктивные и эксплуатационные характеристики.
6. Для сборки изделий рекомендуется привлекать квалифицированных специалистов.

Запах.

От новой мебели может исходить запах материалов, из которых она изготовлена. Запах может сохраняться в течение трёх недель с момента сборки. Для снижения интенсивности запаха рекомендуется:

-для мягкой мебели - пропылесосить изделие и проветрить помещение.

Повторять 3-4 раза в день.

-для корпусной мебели – протирать тканью, смоченной мягким моющим средством, вытирать чистой сухой тканью и проветривать помещение, предварительно открывая все двери и ящики изделия.

Повторять 3-4 раза в день.

Важно! Сохраните, пожалуйста, инструкцию в случае повторной сборки мебели или рекламации. В случае составления рекламации пользуйтесь, пожалуйста, обозначением из инструкции сборки.