

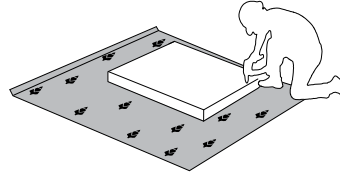

VAŽNO – PRE UPOTREBE PAŽLJIVO PROČITAJTE I SAČUVAJTE UPUTSTVO
IMPORTANT – READ CAREFULLY – RETAIN FOR FUTURE REFERENCE
WICHTIG – SORGFÄLTIG LESEN UND AUFBEWAHREN
ВАЖНО – ПРОЧИТЕ ВНИМАТЕЛЬНО – СОХРАНИТЬ ДЛЯ ДАЛЬНЕЙШЕГО ИСПОЛЬЗОВАНИЯ
WAŻNE – PRZED UŻYCIEM NALEŻY DOKŁADNIE ZAPOZNAĆ SIĘ Z NINIEJSZĄ INSTRUKCJĄ I ZACHOWAĆ JĄ

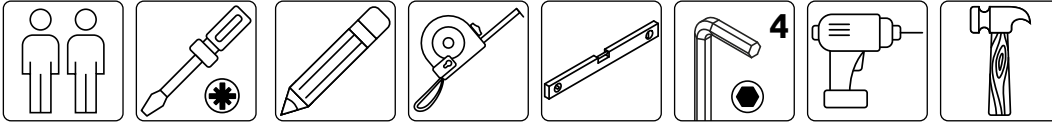

29.09.2022

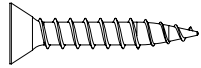

x9 2149	x24 0094 3.5x16	x2 0096 4x18	x12 16535	x16 0122	x16 0063 Ø15x13	x2 32256 V4x23	x8 EKSK4	x1 6319	x4 CEP15	x4 32245	x1 0113 GLUE	x10 CEP8	x4 5547	x4 CEP8-TE								
x9 41439	x2 0104	x1 1321	x1 10397	x4 14067	x2 NIPVC75	x12 EKSPA-18	x8 EKSK4-TEX															
x1 L/2200 54017	<table border="1"> <tbody> <tr> <td>x1 52531</td> <td>x2 0094 3.5x16</td> <td>x4 5547</td> <td>x8 0063 Ø15x13</td> <td>x10 CEP8-BE</td> <td>x8 EKSK4-BE</td> <td>x6 0122</td> <td>x4 CEP15</td> </tr> </tbody> </table>														x1 52531	x2 0094 3.5x16	x4 5547	x8 0063 Ø15x13	x10 CEP8-BE	x8 EKSK4-BE	x6 0122	x4 CEP15
x1 52531	x2 0094 3.5x16	x4 5547	x8 0063 Ø15x13	x10 CEP8-BE	x8 EKSK4-BE	x6 0122	x4 CEP15															

***OPT DP1-10G**

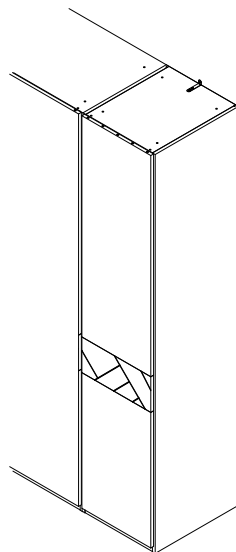

DP1/AV
LWH - 450x555x2236

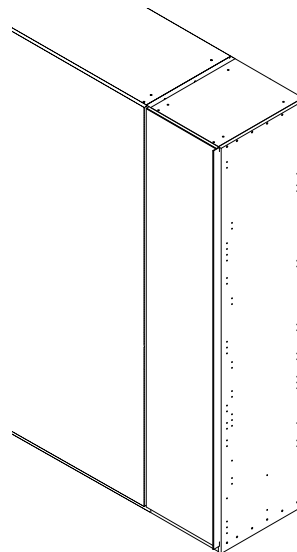

DP1-10G/AV
LWH - 450x555x2236

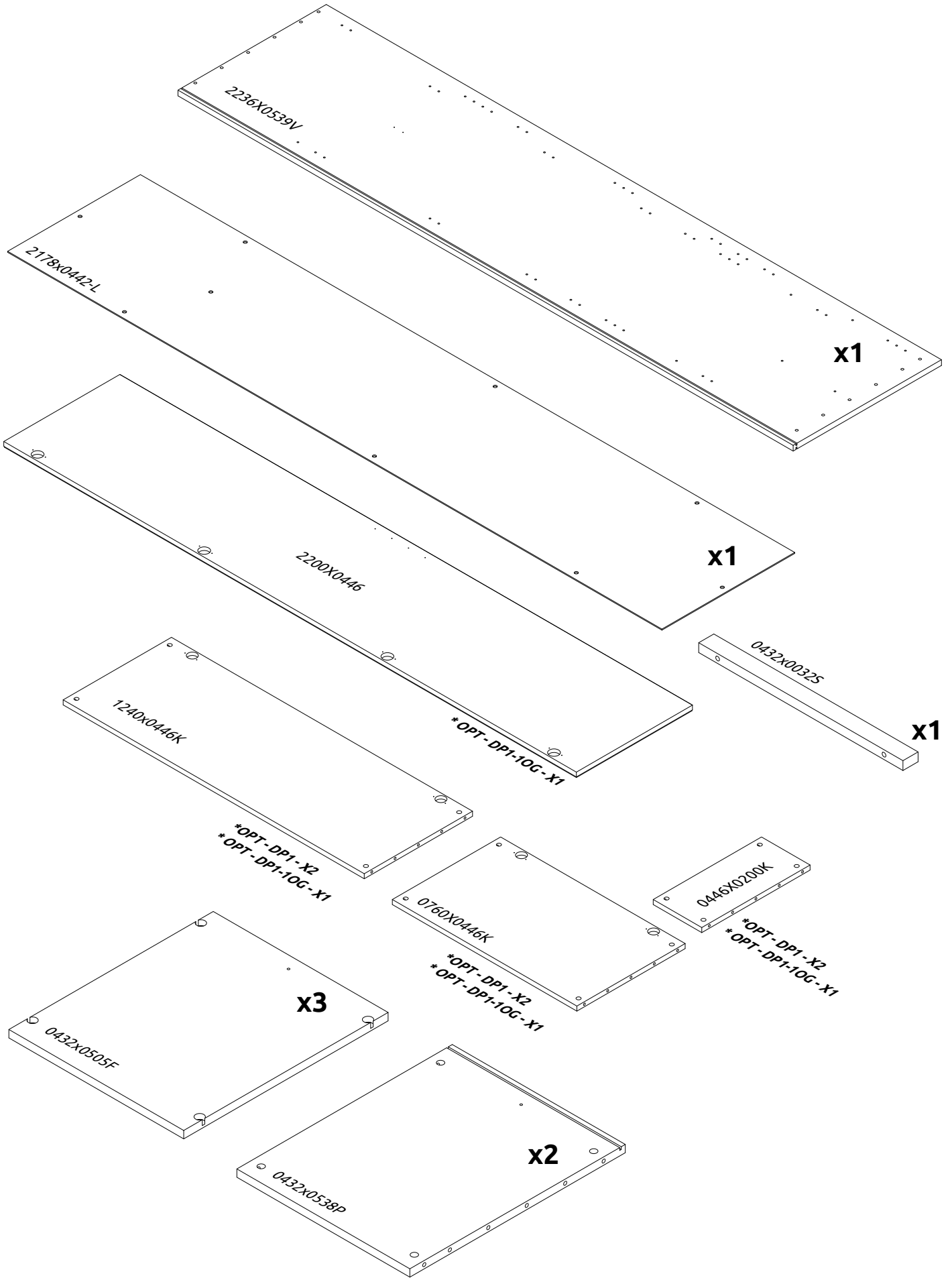

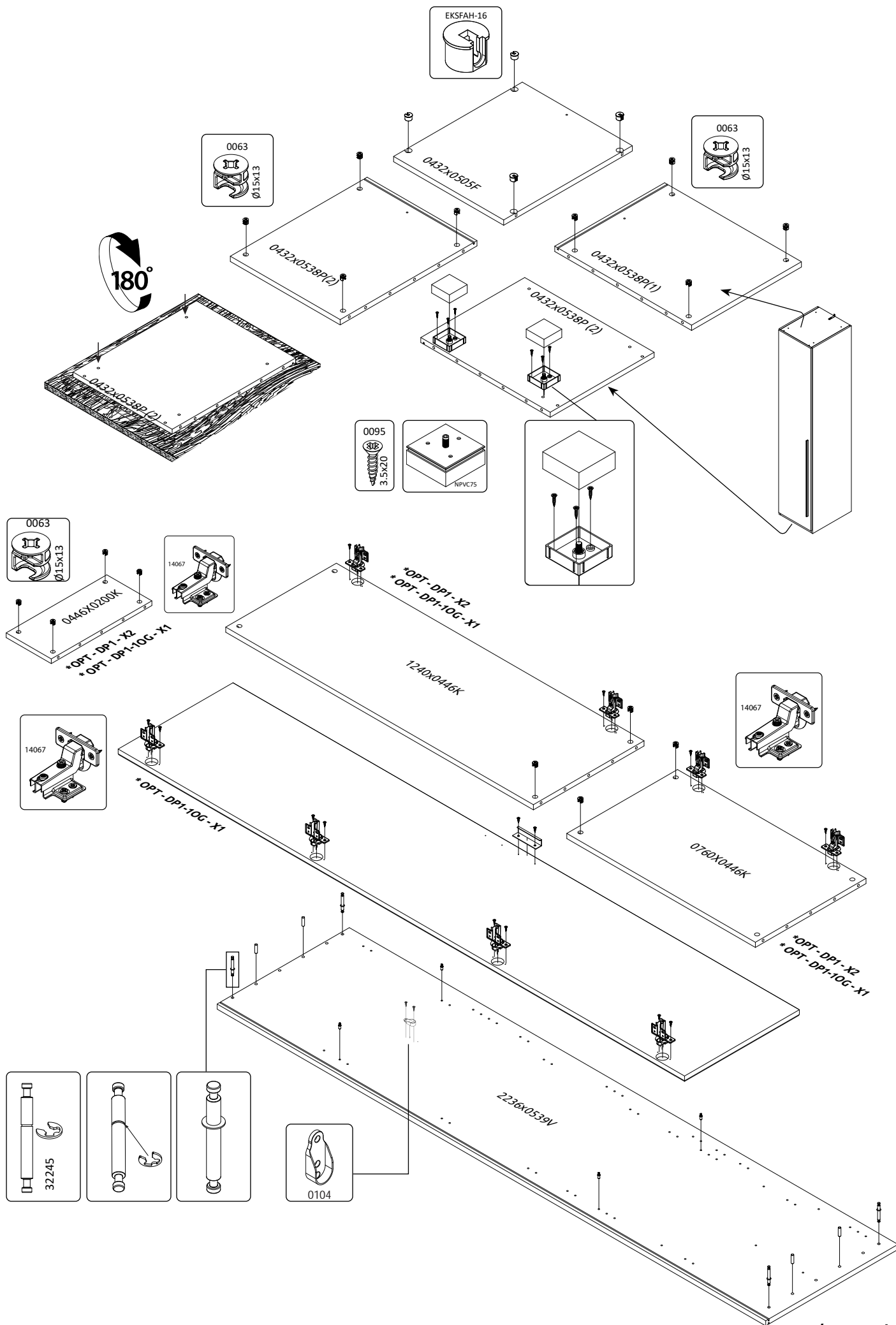

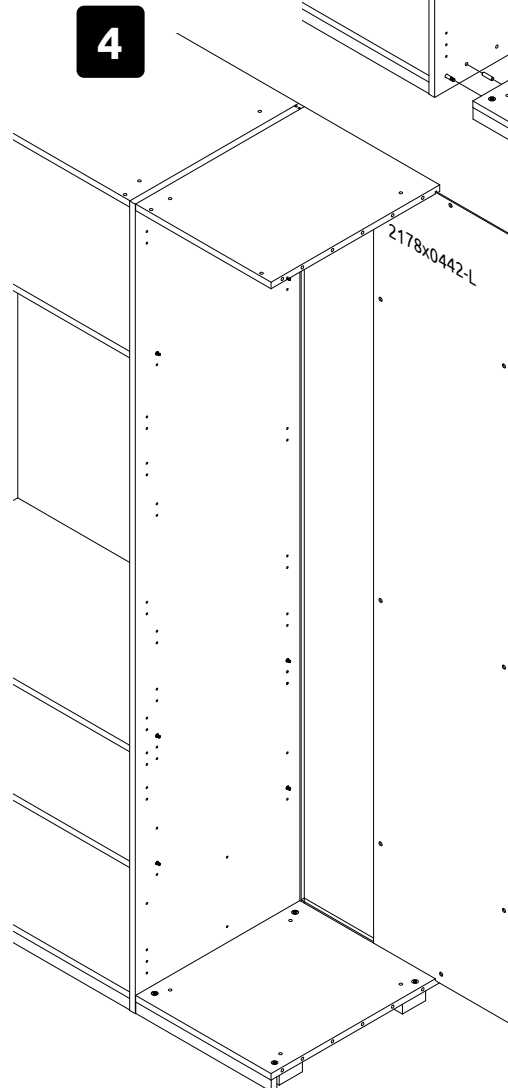
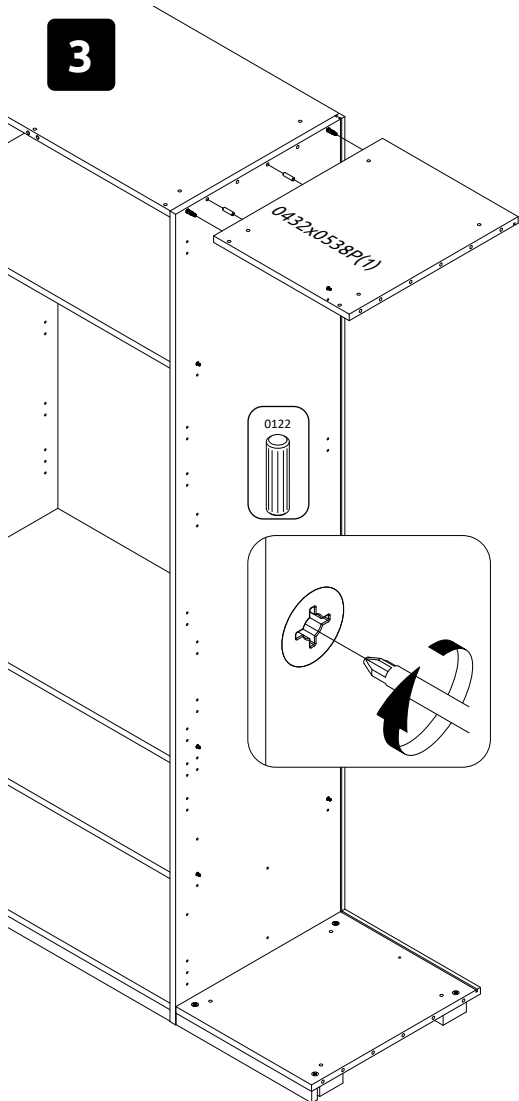
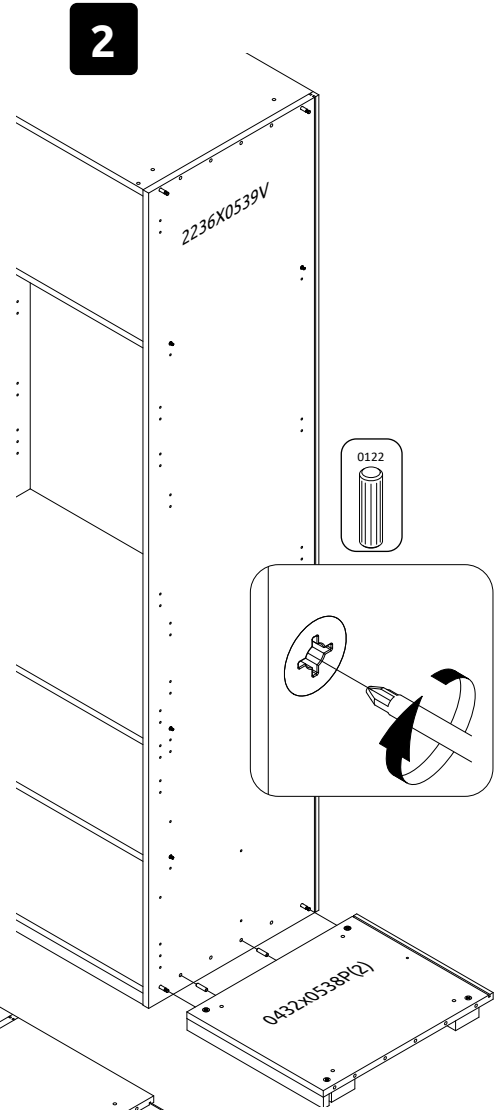
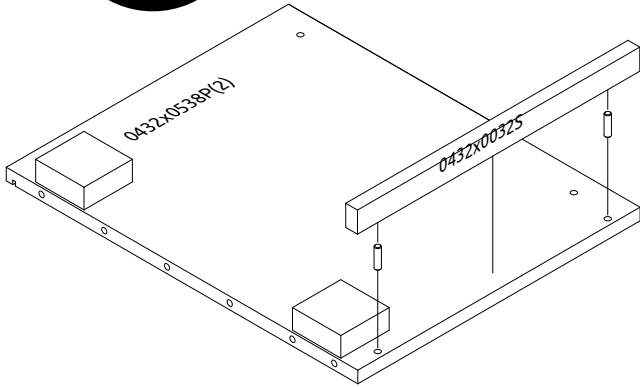
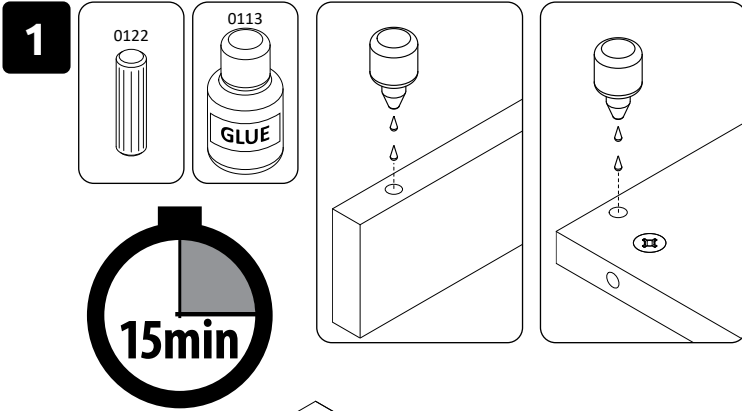

5



opt 1

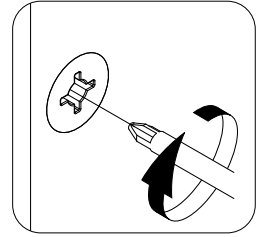
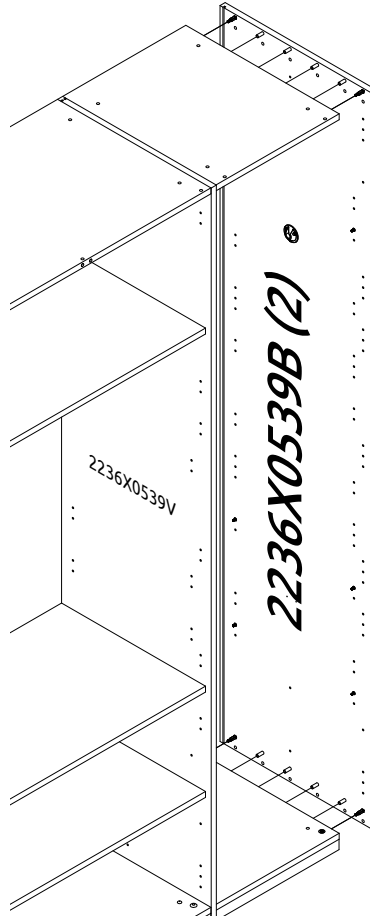
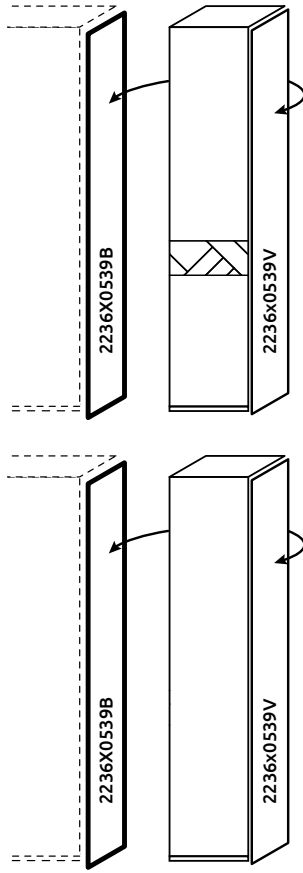

opt 2

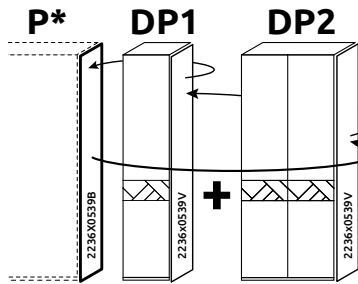

P* = P1 / P2 / DP2



opt 3

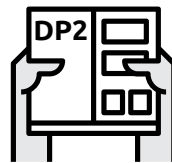
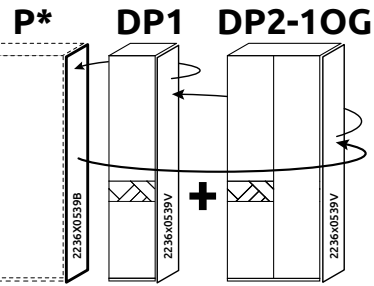

opt 3

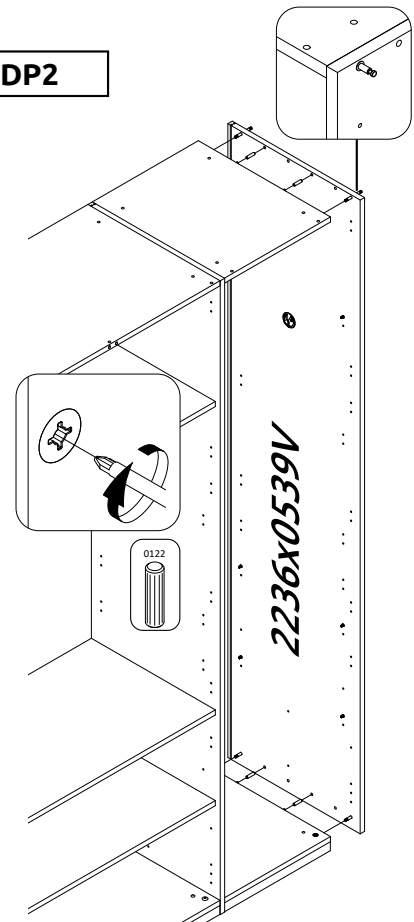
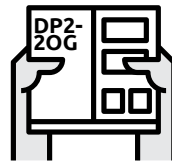
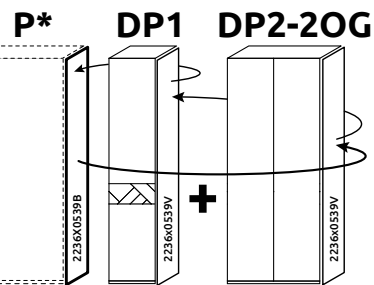

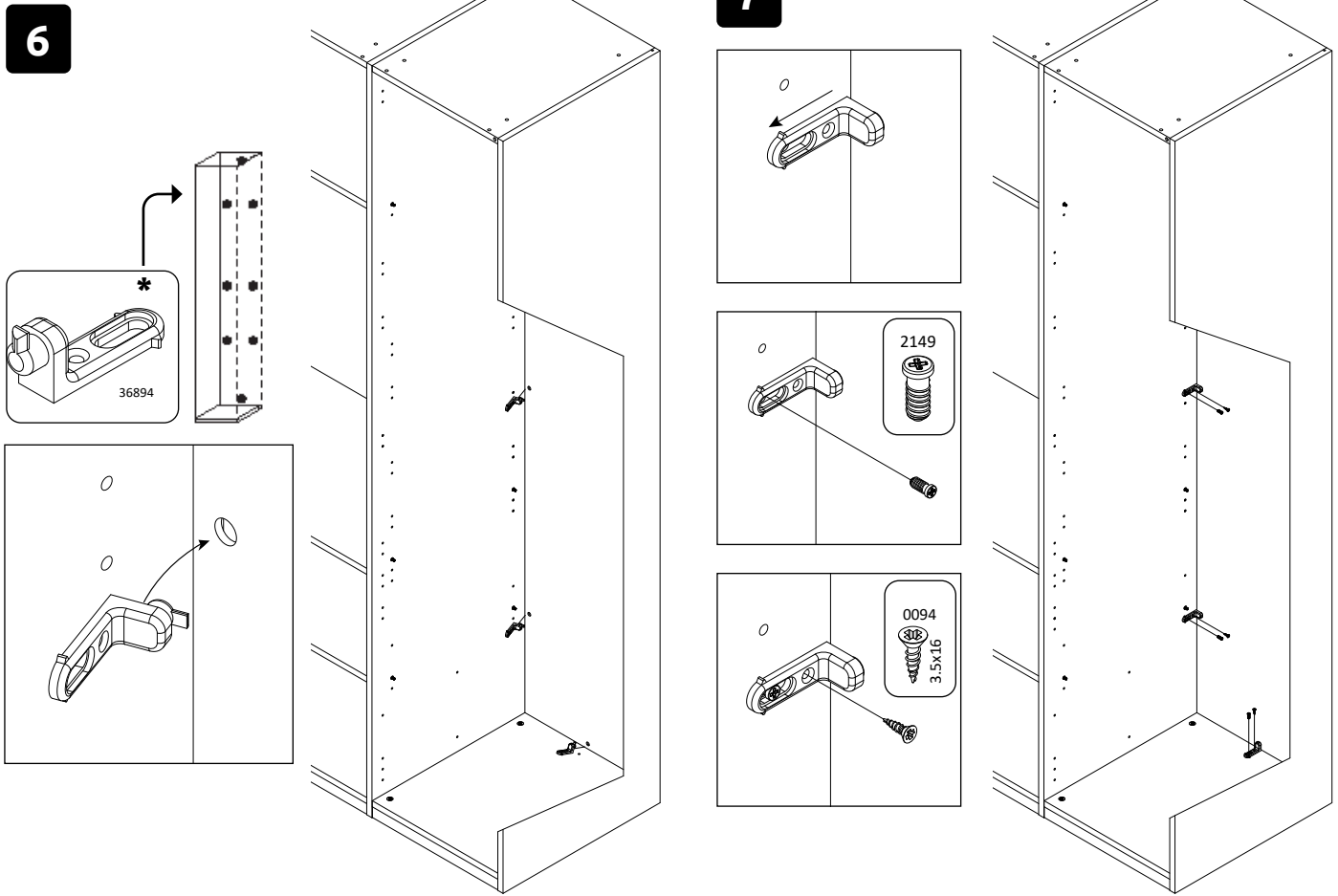
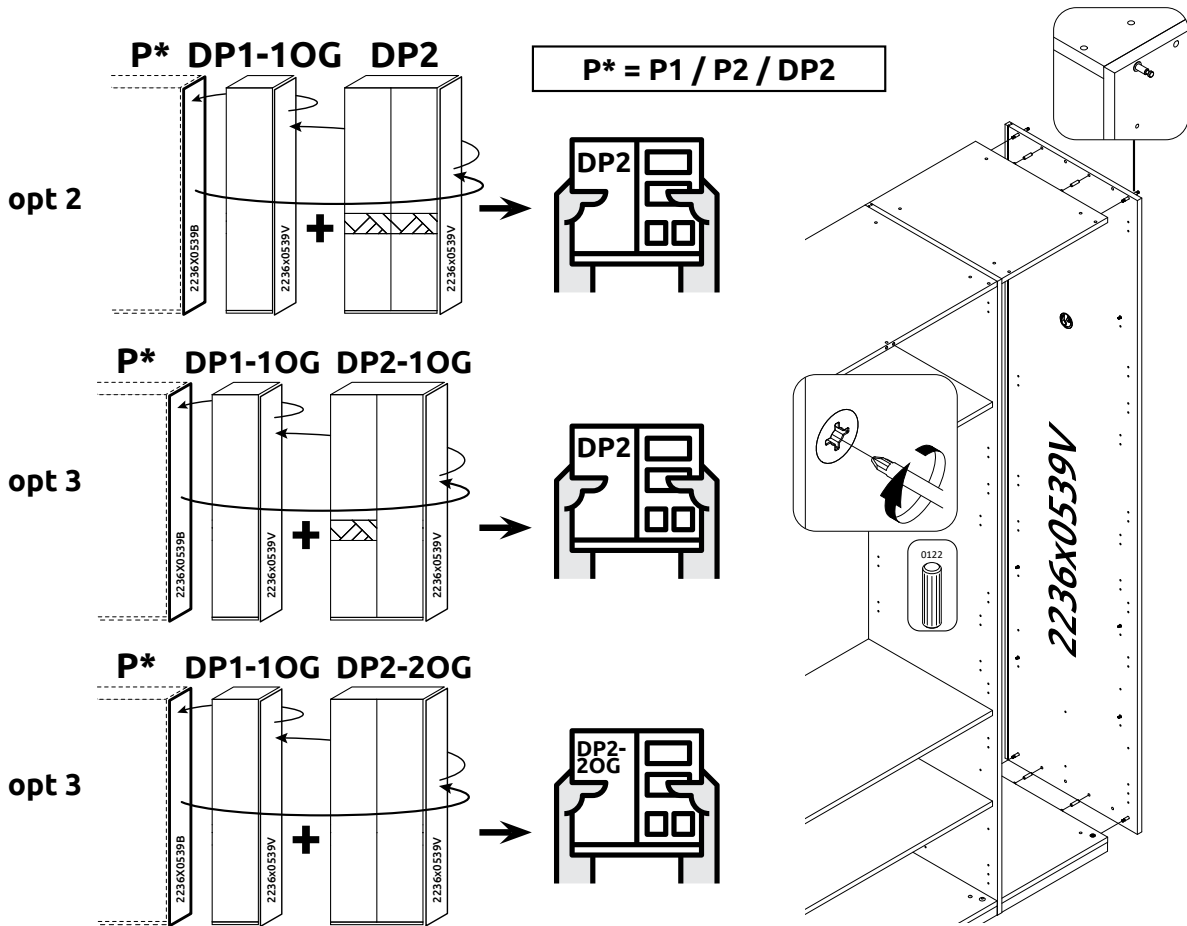

8

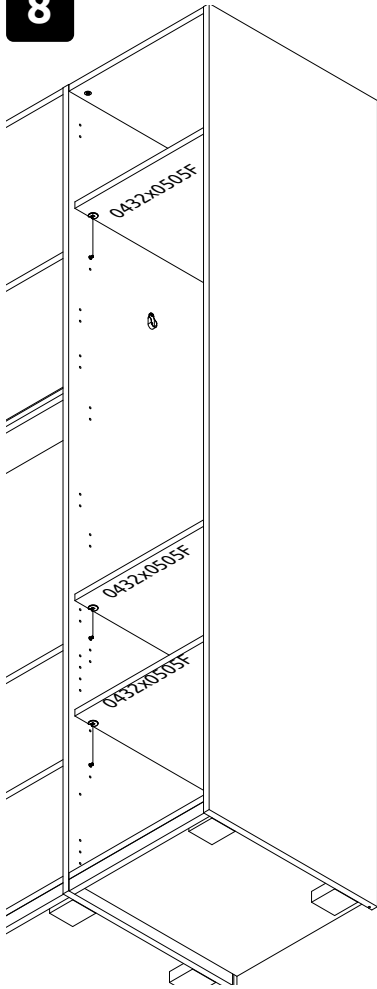

9

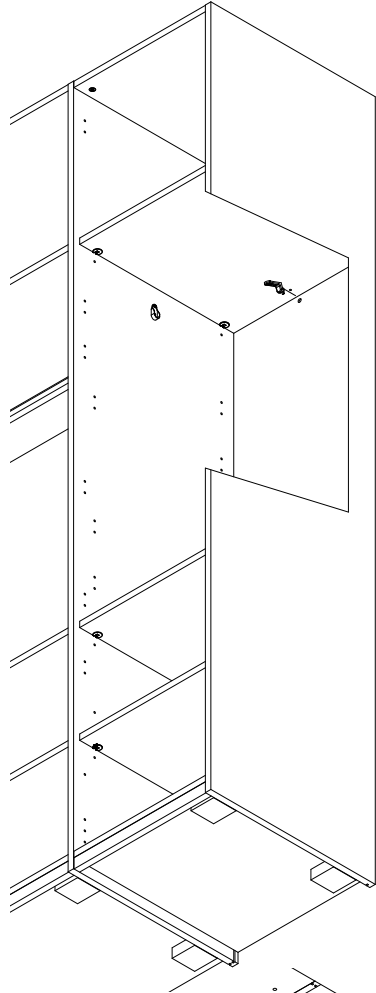
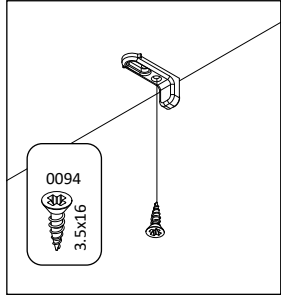
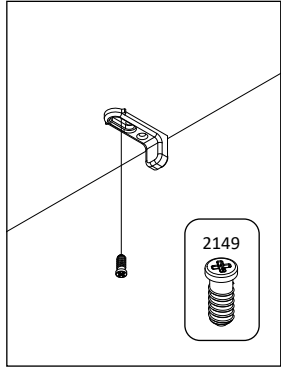
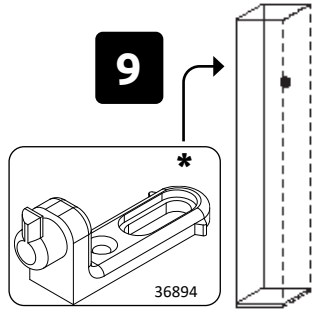

10

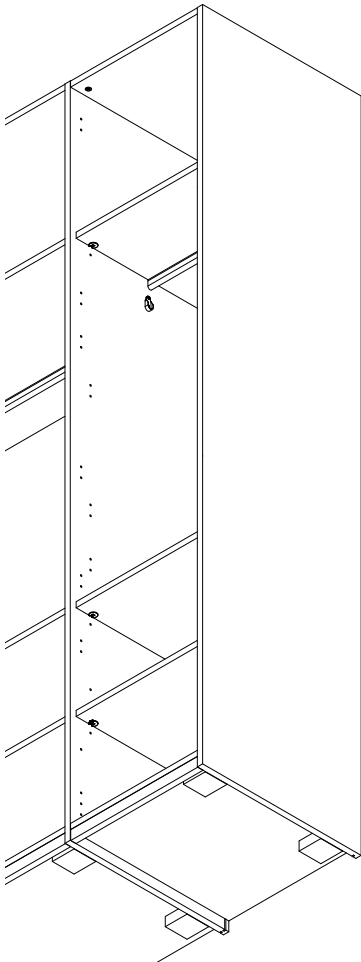

11

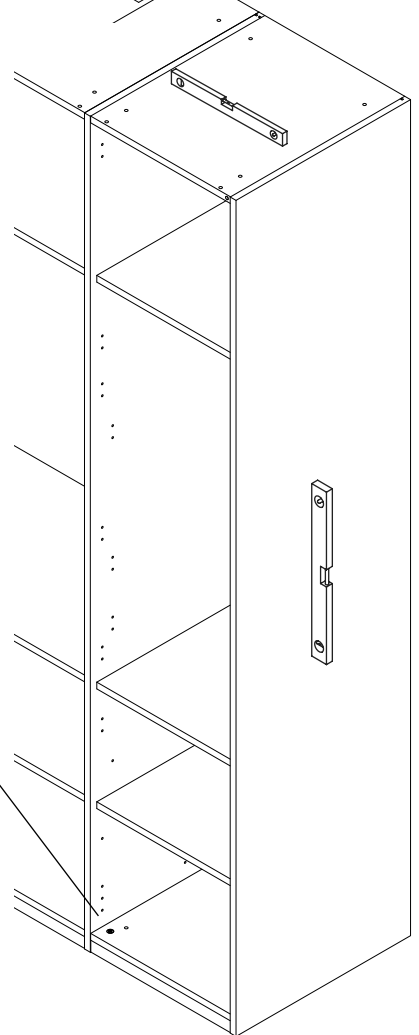
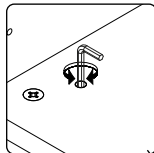
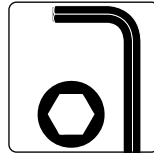
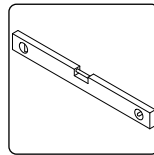

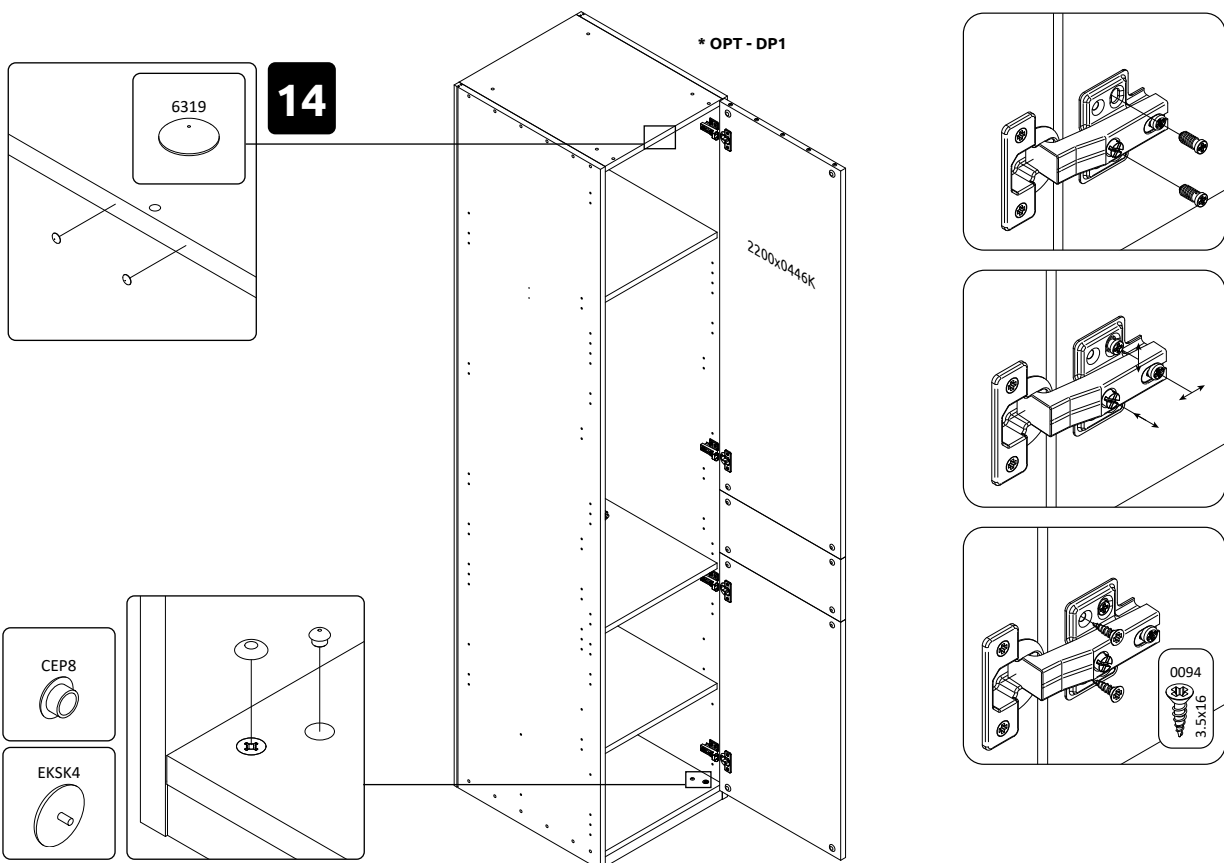
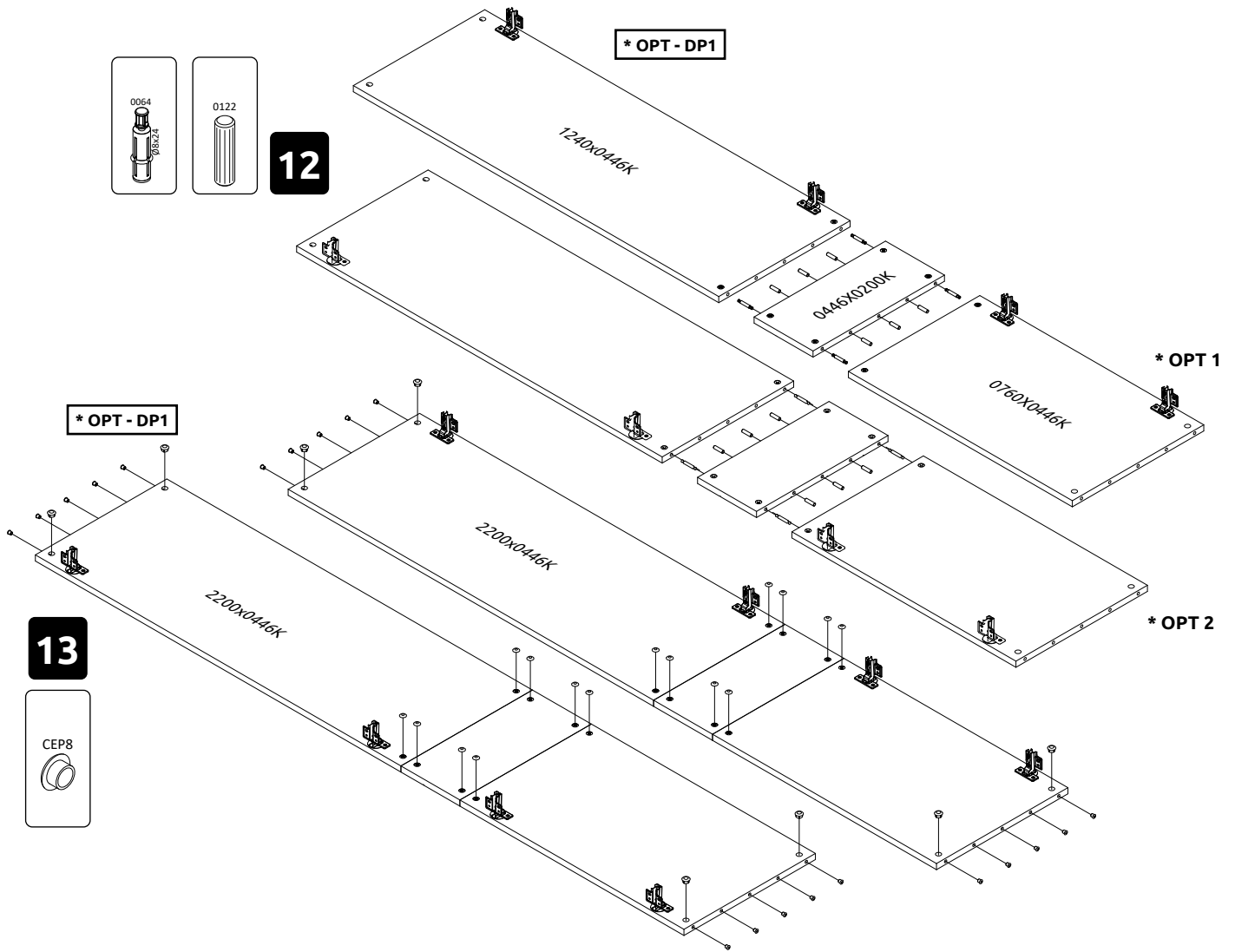

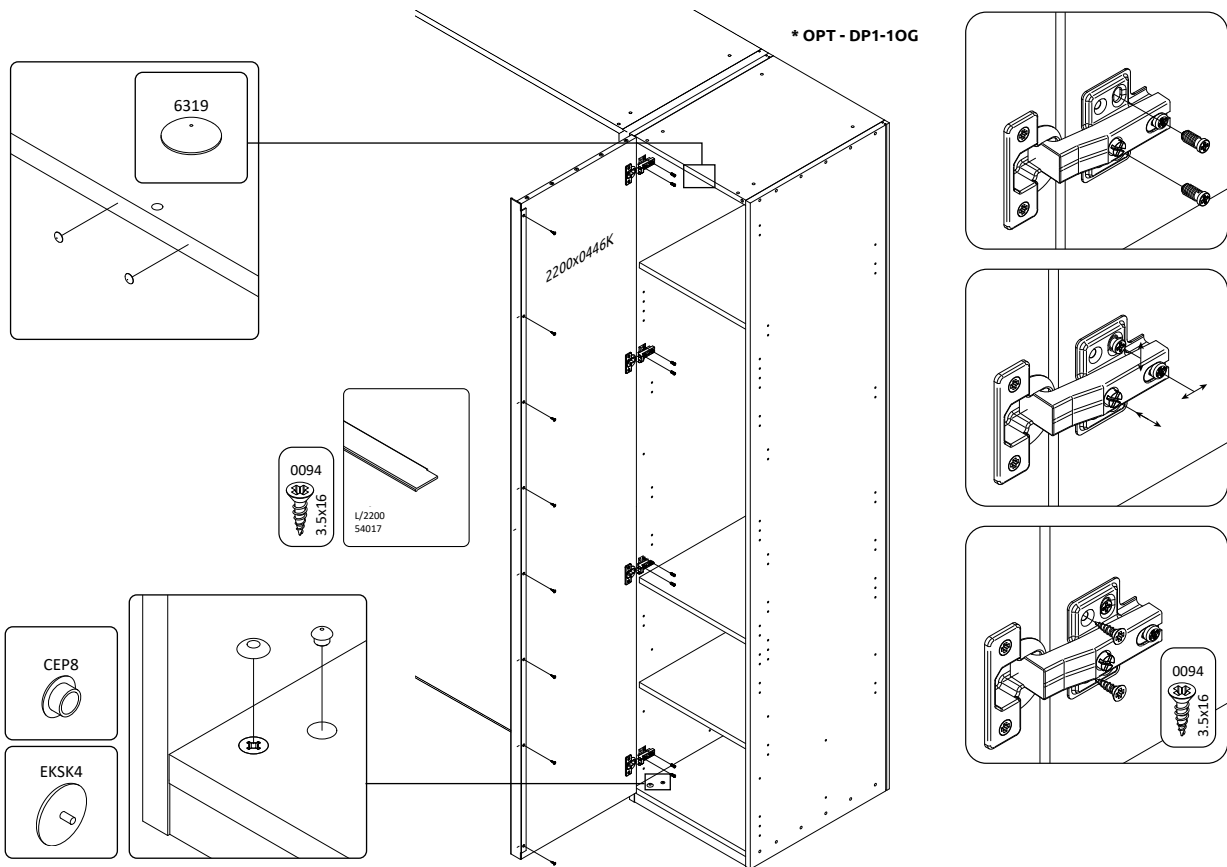

* OPT - DP1-10G

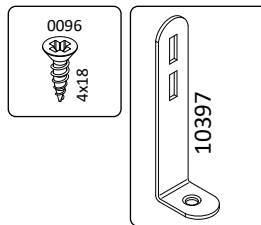
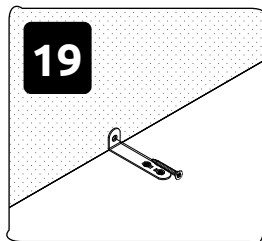
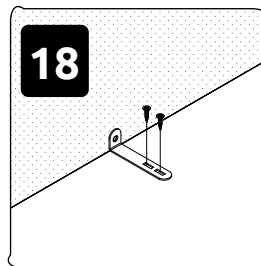
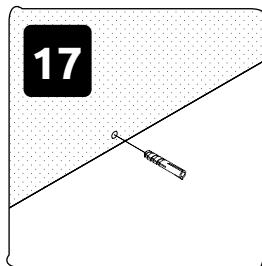
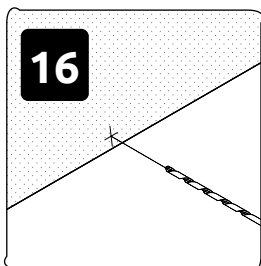
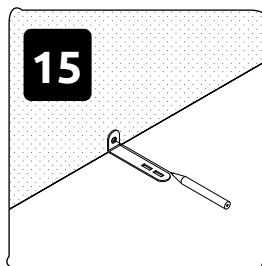
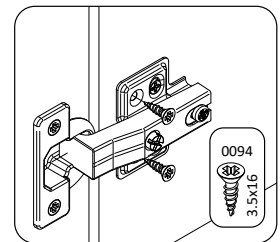
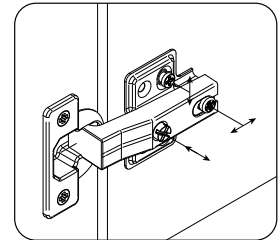
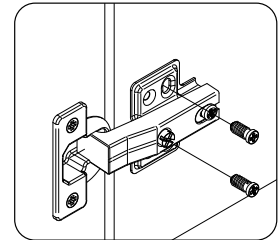

РУССКИЙ
Важная информация
Внимательно прочитайте.
Сохраните эту информацию.

ВНИМАНИЕ
Крепежные средства для
крепления к стене не прилагаются,
для разных материалов стен
требуются различные крепления.
Используйте крепежные средства,
подходящие для материала стен в
Вашем доме. Если Вы не уверены,
какой тип крепления подходит к
данному материалу, обратитесь в
специализированный магазин.

SRPSKI
Bitno!
Pažljivo pročitajte!
Sačuvajte za ubuduće.

UPOZORENJE!
Nisu dati okovi, tiplovi i šrafovi za
pričvršćivanje jer se zidovi razlikuju i
različiti materijali zahtevaju i različite
okove. Upotrebite one koji su pogodni
za zidove u vašem domu. Za savet koje
okove da upotrebite, obratite se u
lokalnoj gvozdari.

ENGLISH
Important information
Read carefully.
Keep this information for further
reference.

WARNING!
Fixing devices for the wall are not
included since different wall materials
require different types of fixing
devices. Use fixing devices suitable for
the walls in your home. For advice on
suitable fixing systems, contact your
local specialized dealer.

DEUTSCH
Wichtige Information Bitte sorgfältig
lesen und aufbewahren!

ACHTUNG HINWEIS!
Beschläge für die Wandbefestigung
sind nicht beige-packt, da sie von
der jeweiligen Wandbeschaffenheit
abhängig sind.
Benutzen Sie ausschließliche
Befestigungsbeschläge, die für die
heimischen Wände geeignet sind.
Bei diesbezüglichen Fragen ziehen Sie
den örtlichen Fachhandel zu Rate.

POLSKI
Ważne!
Uważnie przeczytaj!
Zachować do wykorzystania w
przyszłości.

OSTRZEŻENIE!
Elementy do mocowania w ścianie:
kotwy i wkręty do nich, nie zostały
dostarczone w opakowaniu ponieważ
ściany są wykonane z różnych
materiałów, które wymagają różnych
elementów montażowych.
Prosimy zakupić i zastosować te, które
są odpowiednie do ścian w Państwa
mieszkanu.
Aby uzyskać poradę, jakie elementy
mocujące zastosować, należy
skontaktować się ze sprzedawcami w
wyspecjalizowanym sklepie.

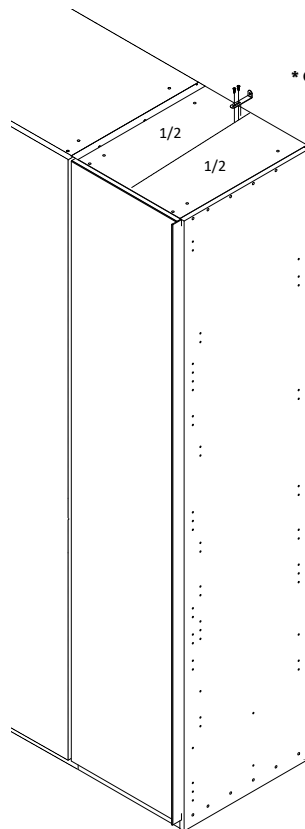

* OPT - DP1-10G

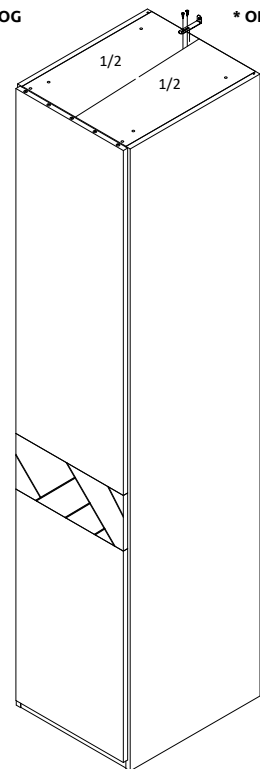

* OPT - DP1